

Pearl[®]

2 0 1 5

COMBO MARCHING CONCERT

P R I C E L I S T



EFFECTIVE JANUARY 1, 2015

THE BEST WARRANTY IN THE INDUSTRY!

COMMITTED TO THE HIGHEST LEVEL OF CUSTOMER SATISFACTION.

The Pearl Lifetime Warranty is a statement of confidence to our customers to the reliability of Pearl products. Pearl drums, stands and hardware are designed and manufactured to the highest standards in quality, style, appearance and playing performance. This lifetime warranty reflects a tradition of excellence and a commitment to superior engineering and craftsmanship dedicated to you, the drummer. The Pearl lifetime warranty is our pledge to you that we will proudly stand behind our product for as long as you own it. Buy it once, play it for life.

Pearl
LIFETIME

- Drum Set/Concert wood and metal shells for the Lifetime of the Original Owner.
- Foot pedals, hi-hat stands, cymbals stands, boom cymbal stands, snare drum stands, throne bases, floor-standing tom stands, floor-standing cymbal/tom stands, concert stands, racks and rack accessories, cymbal holders and multi-clamps for the Lifetime of the Original Owner. Some exceptions apply.
- Drum Set claws, tension rods, swivel nuts, spurs, tom brackets, tom holders, strainers, and nuts and bolts for the Lifetime of the Original Owner.
- Rotationally molded cases for the Lifetime of the Original Owner.
- The LIFETIME WARRANTY applies to the aforementioned Pearl products purchased from June 15, 2009.

Pearl
3 YEARS

- Marching Wood Shells.

Pearl
2 YEARS

- All Pearl Percussion products (except rims, lugs, tuning plates and Taiko heads which have a 1 year warranty).
- All Roadshow drums, stands, pedals, hardware and parts.
- Crystal Beat drums, acrylic shells, lugs, hoops and parts (except OptiMounts which have a LIFETIME WARRANTY)

Pearl
1 YEAR

- SoundCheck drums, stands, pedals, hardware, and parts.
- Covered and lacquered finishes on all Pearl drums.
- RH-2000 Remote Hat cable.
- Collar Joint on all Pearl drum thrones.
- Gas Cylinder on the D-3000TC throne.
- Marching claws, tension rods, swivel nuts, strainers, counterhoops, edge-rings and nuts and bolts.
- Marching carriers and marching carrier parts, except as noted below under "Consumables".
- Marching snare, tom and bass drum stands.
- Marching and Concert wood bass hoops (against manufacturer defect)
- Tru-Trac electronic drum pads and rubber pad surfaces.
- E-Pro Metal and Plastic Cymbals.
- R.E.D. BOX electronic drum module, cables, hi-hat controller, and junction boxes.
- THRONE THUMPER and THRONE THUMPER amplifier.
- PRECISION DRUM MONITOR headphones.
- Snare Kits, Bell Kits, Percussion Learning Centers and their corresponding bags and cases.
- All ADAMS products.
- TUNE-BOT electronic drum tuner

THIS WARRANTY DOESN'T COVER:

- Normal wear and tear.
- Improper assembly.
- Improper follow-up maintenance or repair.
- Installation of non-genuine Pearl parts or components.
- Instruments that have been sold as "B-Stock", sold as second-hand, or resold contrary to US export regulations.
- Instruments that have been altered, modified or have been damaged through misuse, negligence, improper operation or accidents.
- Instruments subjected to abnormal strain, neglect, abuse, modification or exposure to extreme variances in temperature or humidity.
- Instruments whose trademark, name or identification number has been changed or removed.
- Drum hardware and stands plated in Black Chrome, Gold, Satin Chrome, and Black Nickel.
- Drum hardware and stands finished in Black or White Electro-coat.
- Consumables such as but not limited to: heads, sticks, brushes, beaters, springs, straps and buckles, marching slings, cushions and pads for marching carriers, throne tops and cushions, wire snares, cable snares, gut snares, cords/straps, cymbals, drum set, concert and marching bass drum hoops, bass drum hoop protectors, wheels and casters.
- The playing surface on Pearl Percussion Cajons.
- The head on the Pearl Percussion Fun Drum.

OWNER'S RESPONSIBILITY:

It is important that the owner/user be familiar with the proper maintenance and use of their Pearl instrument. Keep this warranty and proof of purchase in a safe place. Be prepared to provide purchase information to avoid undue difficulties in determining eligibility for warranty protection.

HOW TO OBTAIN WARRANTY SERVICE:

Warranty service may be obtained by first notifying the Pearl dealer from which the product was originally purchased. Upon notification, the Pearl dealer must obtain Return Authorization from the Pearl Customer Service Department. This number must be written plainly on the outside of the package or the returned shipping carton will be refused. Returned merchandise must be accompanied by a copy of the original sales receipt. All freight to and from Pearl is to be paid by the customer.

WARRANTY LIMITATIONS:

This Warranty is exclusive and made in lieu of all other warranties, and all implied warranties, including without limitation any warranties of merchantability or of fitness for a particular purpose which are hereby expressly disclaimed. In no event will responsibility be accepted for incidental or consequential damages of any nature whatsoever. Some states do not allow limitation on how long an implied warranty may last. Therefore, the above limitations or exclusions may not apply to you.

This warranty gives you specific legal rights and you may also have other rights which vary from state to state.

Note: This WARRANTY applies to the United States only and may vary in other countries.

PRODUCT INDEX

	Page		Page
WARRANTY	2	MARCHING PEARL CARRIERS & MARCHING STANDS	28
DRUM SETS		CASES & COVERS	28
MASTERWORKS	4 - 5	DRUM KEYS	28
REFERENCE	6	MULTI-USE HOLDERS	28
REFERENCE PURE	7	STICK AND Mallet BAGS	28
MASTERS MCX	8	LALO PAD	28
MASTERS BCX	9	SOUND PROJECTORS FOR SNARE DRUMS	28
SESSION STUDIO CLASSIC SSC	10	SLING ACCESSORIES	28
WOOD FIBERGLASS FW	11	Mallet HOLDERS	28
CRYSTAL BEAT CRB	12	TONE STRIPS	28
VISION BIRCH VBL	13	RIM SHOOTERS	28
EXPORT EXL	14	CHAMPIONSHIP CARBONPLY	29
EXPORT EXX	15	CHAMPIONSHIP MAPLE CARBONCORE	29 - 30
ROADSHOW RS	16	CHAMPIONSHIP FFX SNARE DRUMS	31
RHYTHM TRAVELER & RHYTHM TRAVELER POD	16	CHAMPIONSHIP BASS DRUMS	32 - 33
ROCKET TOMS	16	CHAMPIONSHIP SONIC-CUT TENORS	34 - 35
E-PRO POWERED BY EXPORT	17	CHAMPIONSHIP SHALLOW CUT TENORS	36 - 37
E-PRO COCKTAIL KIT	18	CHAMPIONSHIP TRADITIONAL TENORS	38
TRU-TRAC CONVERSION KITS & ACCESSORIES	18	COMPETITOR	38
SNARE DRUMS	19	PIPE BAND DRUMS	38
HARDWARE	20	REPLACEMENT HOOPS	44
ADAPTERS & ACCESSORIES	21	REPLACEMENT HEADS	44
DRUM PARTS	21	REPLACEMENT SNARES	45
HARDWARE PARTS	22	REPLACEMENT PARTS	45
REPLACEMENT HOOPS & HEADS	23	CONCERT	
PEARL		SNARE DRUMS	39
PERCUSSION		TOMS & BASS DRUMS	39
SIGNATURE SERIES CONGAS & BONGOS	24	STANDS	39
ELITE SERIES CONGAS & BONGOS	24	REPLACEMENT HEADS	44
HAVANA SERIES CONGAS & BONGOS	24	REPLACEMENT HOOPS	44
FOLKLORIC SERIES CONGAS & BONGOS	24	REPLACEMENT SNARES	45
PRIMERO PRO CONGAS & BONGOS	24	REPLACEMENT PARTS	45
PRIMERO CONGAS & BONGOS	24	ADAMS	
TRAVEL CONGAS	24	TIMPANI	40 - 41
CAJONS	25	TIMPANI KEY	41
DJEMBES	25	TIMPANI MUFFLER	41
FRAME DRUMS	25	TIMPANI BAGS & COVERS	41
TIMBALES	25	MARIMBAS	42
STANDS	25	XYLOPHONES	42
HOLDERS & ACCESSORIES	25	VIBRAPHONES	42
TRAP TABLES	26	CONCERT BASS DRUMS	42
ANARCHY SERIES	26	BELLS & GLOCKENSPIELS	43
COWBELLS	26	CHIMES	43
BRAZILIAN PERCUSSION	26	BELL PLATES	43
FIELD PERCUSSION	26	UNIVERSITY FRAMES	43
BANDA PERCUSSION	26	ENDURANCE FIELD FRAMES	43
BAGS	26	ENDURANCE FIELD FRAME RACK SYSTEM	43
HAND PERCUSSION	27	ENDURANCE FIELD FRAME ATTACHMENTS	43
REPLACEMENT PARTS	27	GONG STAND	43
		Mallet INSTRUMENT BAGS & COVERS	43
		REPLACEMENT HEADS	44
		ED KITS	44
		MARCHING & CONCERT COLOR CHART	46

MASTERWORKS:

- CHOICE OF MAPLE, BIRCH, OR AFRICAN MAHOGANY SHELLS
- CHOICE OF SHELL THICKNESS (REFER TO THE SHELL THICKNESS CHARTS)
- CHOICE OF FIBERGLASS INNER PLY
- CHOICE OF SUPER HIGH GLOSS LACQUER FINISHES
- CHOICE OF SUPERHOOP II, DIE CAST HOOPS, FAT TONE HOOPS
- CHOICE BLACK CHROME, GOLD PLATED, OR CHROME PLATED HARDWARE
- GOLDEN RATIO AIR VENTS

MASTERWORKS CARBONPLY MAPLE:

- 6 PLY 5.4MM MAPLE SHELLS
- CARBON FIBER INSIDE AND OUTSIDE
- CHOICE OF SUPERHOOP II, DIE CAST HOOPS, FAT TONE HOOPS
- CHOICE BLACK CHROME, GOLD PLATED, OR CHROME PLATED HARDWARE
- SAME PRICING AS MASTERWORKS
- GOLDEN RATIO AIR VENTS

ARTISAN:

- CHOICE OF MAPLE, BIRCH, OR AFRICAN MAHOGANY SHELLS
- CHOICE OF SHELL THICKNESS (REFER TO THE SHELL THICKNESS CHARTS)
- CHOICE OF TAMO, BUBINGA OR EUCALYPTUS OUTER VENEERS
- CHOICE BLACK CHROME, GOLD PLATED, OR CHROME PLATED HARDWARE
- GOLDEN RATIO AIR VENTS

SNARE DRUMS

MODEL	SIZE	MASTERWORKS	ARTISAN SERIES
MW1040S	10"x4"	\$905.00	\$994.00
MW1055S	10"x5.5"	947.00	1,036.00
MW1065S	10"x6.5"	968.00	1,178.00
MW1240S	12"x4"	968.00	1,063.00
MW1255S	12"x5.5"	1,036.00	1,273.00
MW1265S	12"x6.5"	1,036.00	1,284.00
MW1340S	13"x4"	968.00	1,105.00
MW1355S	13"x5.5"	968.00	1,178.00
MW1365S	13"x6.5"	1,089.00	1,342.00
MW1450S	14"x5"	1,157.00	1,368.00
MW1455S	14"x5.5"	1,157.00	1,368.00
MW1465S	14"x6.5"	1,215.00	1,542.00
MW1480S	14"x8"	1,215.00	1,542.00

SNARE DRUMS - 20 PLY

MODEL	SIZE	MASTERWORKS	ARTISAN SERIES
MW1365S 20 PLY	13"x6.5"	\$1,210.00	\$1,331.00
MW1450S 20 PLY	14"x5"	1,426.00	1,573.00
MW1465S 20 PLY	14"x6.5"	1,426.00	1,573.00

SNARE DRUMS - ONE PLY MAPLE

MODEL	SIZE	MASTERWORKS	ARTISAN SERIES
MW1450SOMC	14"x5"	2,000.00	n/a
MW1455SOMC	14"x5.5"	2,000.00	n/a
MW1465SOMC	14"x6.5"	2,073.00	n/a

SNARE DRUM FEATURES:

- BRL-100 BRIDGE LUGS w/SWIVEL FUNCTION (ON SHELLS 6.5"+ DEEP)
- BRL-55/65 BRIDGE LUGS w/SWIVEL FUNCTION (ON SHELLS 5" ~ 6.5" DEEP)
- STL SWIVEL TUBE LUGS (CHROME ONLY) (ADD \$80 PER DRUM FOR TUBE LUGS)
- STL-100 SINGLE SWIVEL LUGS
- TB-50/55/65 TUBE LUGS (ON SHELLS 5", 5.5" & 6.5" DEEP) (ADD \$80 PER DRUM FOR TUBE LUGS)
- CL-05 LUGS (ON SHELLS 3" TO 4" DEEP)
- STAINLESS STEEL TENSION RODS
- SR-017, SR-015 GLADSTONE-STYLE OR SR-020 MULTI-TRACE STRAINER (ON SHELLS 5"+ DEEP)
- SR-018 STRAINER (ON SHELLS 3" TO 4" DEEP)
- "GOLDEN RATIO" AIR VENTS
- PEARL EXCLUSIVE COATED BATTER HEADS BY REMO
- EXCLUSIVE MASTERWORKS BADGE

SNARE DRUM SHELL THICKNESS ✓ MAPLE ✓ BIRCH ✓ MAHOGANY

DIAMETER	1 PLY 7.5MM	4 PLY 5MM	6 PLY 7.5MM	8 PLY 10MM	10 PLY 12.5MM
10"	-	✓✓✓	✓✓✓	-	-
12"	-	✓✓✓	✓✓✓	✓✓✓	-
13"	-	✓✓✓	✓✓✓	✓✓✓	-
14"	✓✓✓	✓✓✓	✓✓✓	✓✓✓	✓✓✓

BASS DRUMS

MODEL	SIZE	MASTERWORKS	ARTISAN SERIES
MW1810B	18"x10"	\$2,547.00	\$3,468.00
MW1811B	18"x11"	2,547.00	3,468.00
MW1812B	18"x12"	2,547.00	3,468.00
MW1813B	18"x13"	2,547.00	3,468.00
MW1814B	18"x14"	2,547.00	3,468.00
MW1815B	18"x15"	2,547.00	3,468.00
MW1816B	18"x16"	2,547.00	3,468.00
MW1817B	18"x17"	2,547.00	3,468.00
MW1818B	18"x18"	2,547.00	3,468.00
MW2010B	20"x10"	2,673.00	3,531.00
MW2011B	20"x11"	2,673.00	3,531.00
MW2012B	20"x12"	2,673.00	3,531.00
MW2013B	20"x13"	2,673.00	3,531.00
MW2014B	20"x14"	2,673.00	3,531.00
MW2015B	20"x15"	2,673.00	3,531.00
MW2016B	20"x16"	2,673.00	3,531.00
MW2017B	20"x17"	2,673.00	3,531.00
MW2018B	20"x18"	2,673.00	3,531.00
MW2210B	22"x10"	2,857.00	3,705.00
MW2211B	22"x11"	2,857.00	3,705.00
MW2212B	22"x12"	2,857.00	3,705.00
MW2213B	22"x13"	2,857.00	3,705.00
MW2214B	22"x14"	2,857.00	3,705.00
MW2215B	22"x15"	2,857.00	3,705.00
MW2216B	22"x16"	2,857.00	3,705.00
MW2217B	22"x17"	2,857.00	3,705.00
MW2218B	22"x18"	2,857.00	3,705.00
MW2220B	22"x20"	2,857.00	3,705.00
MW2410B	24"x10"	2,915.00	3,821.00
MW2411B	24"x11"	2,915.00	3,821.00
MW2412B	24"x12"	2,915.00	3,821.00
MW2413B	24"x13"	2,915.00	3,821.00
MW2414B	24"x14"	2,915.00	3,821.00
MW2415B	24"x15"	2,915.00	3,821.00
MW2416B	24"x16"	2,915.00	3,821.00
MW2417B	24"x17"	2,915.00	3,821.00
MW2418B	24"x18"	2,915.00	3,821.00
MW2610B	26"x10"	3,010.00	3,947.00
MW2611B	26"x11"	3,010.00	3,947.00
MW2612B	26"x12"	3,010.00	3,947.00
MW2613B	26"x13"	3,010.00	3,947.00
MW2614B	26"x14"	3,010.00	3,947.00
MW2615B	26"x15"	3,010.00	3,947.00
MW2616B	26"x16"	3,010.00	3,947.00

BASS DRUM FEATURES:

- CHOICE OF CL, BRL OR STL LUGS
- CW-300 RECESSED DIE CAST CLAWS w/RUBBER "HOOP SAVERS"
- SP-300 BRIDGE SPURS
- 2" WIDE WOOD HOOPS
- STAINLESS STEEL TENSION RODS
- ORDER WITH OR WITHOUT BB-3 BRACKET
- "GOLDEN RATIO" AIR VENTS
- PEARL EXCLUSIVE REMO COATED POWERSTROKE 4 BATTER HEAD
- PEARL EXCLUSIVE REMO COATED POWERSTROKE 3 RESONATOR HEAD
- EXCLUSIVE MASTERWORKS BADGE



BASS DRUM SHELL THICKNESS ✓ MAPLE ✓ BIRCH ✓ MAHOGANY

DIAMETER	4 PLY 5MM	6 PLY 7.5MM	8 PLY 10MM	10 PLY 12.5MM
18"	✓✓✓	✓✓✓	✓✓✓	✓✓✓
20"	✓✓✓	✓✓✓	✓✓✓	✓✓✓
22"	✓✓✓	✓✓✓	✓✓✓	✓✓✓
24"	✓✓✓	✓✓✓	✓✓✓	✓✓✓
26"	✓✓✓	✓✓✓	-	-

TOMS

MODEL	SIZE	MASTERWORKS	ARTISAN SERIES
MW0807T	8"x7"	\$973.00	\$1,084.00
MW0808T	8"x8"	973.00	1,084.00
MW1007T	10"x7"	1,068.00	1,242.00
MW1008T	10"x8"	1,068.00	1,242.00
MW1009T	10"x9"	1,068.00	1,242.00
MW1010T	10"x10"	1,068.00	1,242.00
MW1207T	12"x7"	1,147.00	1,368.00
MW1208T	12"x8"	1,147.00	1,368.00
MW1209T	12"x9"	1,147.00	1,368.00
MW1210T	12"x10"	1,147.00	1,368.00
MW1211T	12"x11"	1,147.00	1,368.00
MW1212T	12"x12"	1,147.00	1,368.00
MW1307T	13"x7"	1,236.00	1,547.00
MW1308T	13"x8"	1,236.00	1,547.00
MW1309T	13"x9"	1,236.00	1,547.00
MW1310T	13"x10"	1,236.00	1,547.00
MW1311T	13"x11"	1,236.00	1,547.00
MW1312T	13"x12"	1,236.00	1,547.00
MW1313T	13"x13"	1,236.00	1,547.00
MW1407T	14"x7"	1,368.00	1,657.00
MW1408T	14"x8"	1,368.00	1,657.00
MW1409T	14"x9"	1,368.00	1,657.00
MW1410T	14"x10"	1,368.00	1,657.00
MW1411T	14"x11"	1,368.00	1,657.00
MW1412T	14"x12"	1,368.00	1,657.00
MW1413T	14"x13"	1,368.00	1,657.00
MW1414T	14"x14"	1,368.00	1,657.00
MW1507T	15"x7"	1,484.00	1,815.00
MW1508T	15"x8"	1,484.00	1,815.00
MW1509T	15"x9"	1,484.00	1,815.00
MW1510T	15"x10"	1,484.00	1,815.00
MW1511T	15"x11"	1,484.00	1,815.00
MW1512T	15"x12"	1,484.00	1,815.00
MW1513T	15"x13"	1,484.00	1,815.00
MW1514T	15"x14"	1,484.00	1,815.00
MW1515T	15"x15"	1,484.00	1,815.00
MW1607T	16"x7"	1,563.00	1,968.00
MW1608T	16"x8"	1,563.00	1,968.00
MW1609T	16"x9"	1,563.00	1,968.00
MW1610T	16"x10"	1,563.00	1,968.00
MW1611T	16"x11"	1,563.00	1,968.00
MW1612T	16"x12"	1,563.00	1,968.00
MW1613T	16"x13"	1,563.00	1,968.00
MW1614T	16"x14"	1,563.00	1,968.00
MW1615T	16"x15"	1,563.00	1,968.00
MW1616T	16"x16"	1,563.00	1,968.00

TOM FEATURES:

- CHOICE OF CL, BRL OR STL LUGS
- CHOICE OF SUPERHOOP II, DIE CAST OR FAT TONE HOOPS
- STAINLESS STEEL TENSION RODS
- ALUMINUM OPTIMOUNT SUSPENSION SYSTEM
- "GOLDEN RATIO" AIR VENTS
- PEARL EXCLUSIVE COATED BATTER HEADS BY REMO
- EXCLUSIVE MASTERWORKS BADGE

TOM SHELL THICKNESS

✓ MAPLE ✓ BIRCH ✓ MAHOGANY

DIAMETER	4 PLY 5MM	6 PLY 7.5MM	8 PLY 10MM	10 PLY 12.5MM
8"	✓✓✓	✓✓✓	-	-
10"	✓✓✓	✓✓✓	✓✓✓	-
12"	✓✓✓	✓✓✓	✓✓✓	-
13"	✓✓✓	✓✓✓	✓✓✓	-
14"	✓✓✓	✓✓✓	✓✓✓	✓✓✓
15"	✓✓✓	✓✓✓	✓✓✓	-
16"	✓✓✓	✓✓✓	✓✓✓	✓✓✓

FLOOR TOMS

MODEL	SIZE	MASTERWORKS	ARTISAN SERIES
MW1407F	14"x7"	\$1,589.00	\$1,978.00
MW1408F	14"x8"	1,589.00	1,978.00
MW1409F	14"x9"	1,589.00	1,978.00
MW1410F	14"x10"	1,589.00	1,978.00
MW1411F	14"x11"	1,589.00	1,978.00
MW1412F	14"x12"	1,589.00	1,978.00
MW1413F	14"x13"	1,589.00	1,978.00
MW1414F	14"x14"	1,589.00	1,978.00
MW1507F	15"x7"	1,642.00	2,142.00
MW1508F	15"x8"	1,642.00	2,142.00
MW1509F	15"x9"	1,642.00	2,142.00
MW1510F	15"x10"	1,642.00	2,142.00
MW1511F	15"x11"	1,642.00	2,142.00
MW1512F	15"x12"	1,642.00	2,142.00
MW1513F	15"x13"	1,642.00	2,142.00
MW1514F	15"x14"	1,642.00	2,142.00
MW1515F	15"x15"	1,642.00	2,142.00
MW1607F	16"x7"	1,700.00	2,200.00
MW1608F	16"x8"	1,700.00	2,200.00
MW1609F	16"x9"	1,700.00	2,200.00
MW1610F	16"x10"	1,700.00	2,200.00
MW1611F	16"x11"	1,700.00	2,200.00
MW1612F	16"x12"	1,700.00	2,200.00
MW1613F	16"x13"	1,700.00	2,200.00
MW1614F	16"x14"	1,700.00	2,200.00
MW1615F	16"x15"	1,700.00	2,200.00
MW1616F	16"x16"	1,700.00	2,200.00
MW1807F	18"x7"	1,936.00	2,642.00
MW1808F	18"x8"	1,936.00	2,642.00
MW1809F	18"x9"	1,936.00	2,642.00
MW1810F	18"x10"	1,936.00	2,642.00
MW1811F	18"x11"	1,936.00	2,642.00
MW1812F	18"x12"	1,936.00	2,642.00
MW1813F	18"x13"	1,936.00	2,642.00
MW1814F	18"x14"	1,936.00	2,642.00
MW1815F	18"x15"	1,936.00	2,642.00
MW1816F	18"x16"	1,936.00	2,642.00
MW1817F	18"x17"	1,936.00	2,642.00
MW1818F	18"x18"	1,936.00	2,642.00

FLOOR TOM FEATURES:

- CHOICE OF CL, BRL OR STL LUGS
- LB-200 BRIDGE LEG BRACKET W/CLAM SHELL SYSTEM
- LG-200 FLOOR TOM LEGS w/AIR SUSPENSION FEET
- EXTRA LONG 27" LEGS (ON FLOOR TOMS 15" AND SHORTER IN DEPTH)
- CHOICE OF SUPERHOOP II, DIE CAST OR FAT TONE HOOPS
- STAINLESS STEEL TENSION RODS
- "GOLDEN RATIO" AIR VENTS
- PEARL EXCLUSIVE COATED BATTER HEADS BY REMO
- EXCLUSIVE MASTERWORKS BADGE



FLOOR TOM SHELL THICKNESS

✓ MAPLE ✓ BIRCH ✓ MAHOGANY

DIAMETER	4 PLY 5MM	6 PLY 7.5MM	8 PLY 10MM	10 PLY 12.5MM
14"	✓✓✓	✓✓✓	-	✓✓✓
15"	✓✓✓	✓✓✓	✓✓✓	-
16"	✓✓✓	✓✓✓	✓✓✓	✓✓✓
18"	✓✓✓	✓✓✓	✓✓✓	✓✓✓

RF REFERENCE

SHELL MATERIAL: "BEST OF MASTERWORKS"
FINISHES: SUPER HIGH GLOSS LACQUER/LACQUER SPARKLES

SHELL PACKS

RF 924XP **\$5,830**

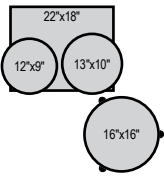

INCLUDES:

RF 2218BX	22"x18"	BASS
RF 1209T	12"x9"	TOM
RF 1310T	13"x10"	TOM
RF 1616F	16"x16"	FLOOR TOM

RF 924XSP **\$5,830**

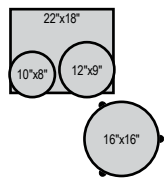

INCLUDES:

RF 2218BX	22"x18"	BASS
RF 1008T	10"x8"	TOM
RF 1209T	12"x9"	TOM
RF 1616F	16"x16"	FLOOR TOM

RF 904XP **\$5,830**

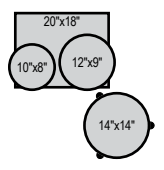

INCLUDES:

RF 2018BX	20"x18"	BASS
RF 1008T	10"x8"	TOM
RF 1209T	12"x9"	TOM
RF 1414F	14"x14"	FLOOR TOM

SHELL COMPOSITION

LEGEND: M= MAPLE; B= BIRCH; MH= AFRICAN MAHOGANY

SNARE DRUMS	PLIES	THICKNESS	OUTSIDE / INSIDE	BEARING EDGE
13"	20	25MM	M14 / B6	45°
14"	20	25MM	M14 / B6	45°

TOMS	PLIES	THICKNESS	OUTSIDE / INSIDE	BEARING EDGE
8"	6	7.5MM	M4 / B2	ROUNDED 45°
10"	6	7.5MM	M4 / B2	ROUNDED 45°
12"	6	7.5MM	M6	ROUNDED 45°
13"	6	7.5MM	M4 / MH2	ROUNDED 45°
14"	6	7.5MM	M4 / MH2	FULLY ROUNDED
15"	6	7.5MM	M4 / MH2	FULLY ROUNDED
16"	6	7.5MM	M2 / MH4	FULLY ROUNDED

FLOOR TOMS	PLIES	THICKNESS	OUTSIDE / INSIDE	BEARING EDGE
14"	8	10MM	M4 / MH4	FULLY ROUNDED
15"	8	10MM	M4 / MH4	FULLY ROUNDED
16"	8	10MM	M2 / MH6	FULLY ROUNDED
18"	8	10MM	M2 / MH6	FULLY ROUNDED

BASS DRUMS	PLIES	THICKNESS	OUTSIDE / INSIDE	BEARING EDGE
18"	6	7.5MM	M2 / MH4	FULLY ROUNDED
20"	6	7.5MM	M2 / MH4	FULLY ROUNDED
22"	8	10MM	M2 / MH6	FULLY ROUNDED
24"	8	10MM	M2 / MH6	FULLY ROUNDED

COMPONENTS

SNARE DRUMS		
RF 1365S	13"x6.5"	\$1,250.00
RF 1450S	14"x5"	1,200.00
RF 1465S	14"x6.5"	1,300.00
RFS 1450	14"x5"	1,300.00
RFS 1465	14"x6.5"	1,365.00
RFB 1450	14"x5"	1,650.00
RFB 1465	14"x6.5"	1,830.00

TOMS		
RF 0807T	8"x7"	\$730.00
RF 0808T	8"x8"	730.00
RF 1007T	10"x7"	850.00
RF 1008T	10"x8"	850.00
RF 1009T	10"x9"	850.00
RF 1010T*	10"x10"	850.00
RF 1208T	12"x8"	880.00
RF 1209T	12"x9"	880.00
RF 1210T	12"x10"	880.00
RF 1309T*	13"x9"	980.00
RF 1310T	13"x10"	980.00
RF 1311T*	13"x11"	980.00
RF 1410T*	14"x10"	1,130.00
RF 1411T	14"x11"	1,130.00
RF 1412T	14"x12"	1,130.00
RF 1513T*	15"x13"	1,180.00
RF 1514T	15"x14"	1,180.00
RF 1613T	16"x13"	1,280.00
RF 1614T	16"x14"	1,280.00

FLOOR TOMS		
RF1414F	14"x14"	\$1,150.00
RF1616F	16"x16"	1,265.00
RF1816F	18"x16"	1,500.00

BASS DRUMS w/BB-3		
RF 1814BB*	18"x14"	\$1,900.00
RF 1816BB*	18"x16"	1,900.00
RF 2014BB*	20"x14"	1,965.00
RF 2016BB*	20"x16"	1,965.00
RF 2018BB*	20"x18"	1,980.00
NEW RF 2214BB*	22"x14"	2,265.00
RF 2216BB*	22"x16"	2,265.00
RF 2218BB*	22"x18"	2,265.00
RF 2220BB*	22"x20"	2,415.00
NEW RF 2414BB*	24"x14"	2,415.00
RF 2416BB*	24"x16"	2,415.00
RF 2418BB*	24"x18"	2,450.00

BASS DRUMS w/o BB-3		
RF 1814BX*	18"x14"	\$1,900.00
RF 1816BX*	18"x16"	1,900.00
RF 2014BX*	20"x14"	1,965.00
RF 2016BX	20"x16"	1,965.00
RF 2018BX*	20"x18"	1,980.00
NEW RF 2214BX*	22"x14"	2,265.00
RF 2216BX	22"x16"	2,265.00
RF 2218BX	22"x18"	2,265.00
RF 2220BX*	22"x20"	2,415.00
NEW RF 2414BX*	24"x14"	2,415.00
RF 2416BX*	24"x16"	2,415.00
RF 2418BX	24"x18"	2,450.00

GONG DRUM w 2 X BB-3		
RF 2014G*	20"x14"	\$1,565.00

*SPECIAL ORDER ONLY
PLEASE ALLOW 3 TO 5 MONTHS
FOR DELIVERY

FINISHES

LACQUER w/CHROME, BLACK CHROME or GOLD PLATED DRUM HARDWARE

#100 WINE RED	SPECIAL ORDER
#102 NATURAL MAPLE	IN STOCK
#103 PIANO BLACK	IN STOCK
#109 ARCTIC WHITE	SPECIAL ORDER
#126 EMERALD MIST	SPECIAL ORDER
#128 VINTAGE SUNBURST	SPECIAL ORDER
#142 ROOTBEER FADE	SPECIAL ORDER
#143 TWILIGHT FADE	SPECIAL ORDER
#148 EMERALD FADE	SPECIAL ORDER
#151 PLATINUM MIST	SPECIAL ORDER
#152 ANTIQUE GOLD	SPECIAL ORDER
#153 SUNRISE FADE	SPECIAL ORDER
#154 MIDNIGHT FADE	SPECIAL ORDER
#155 SCARLET FADE	SPECIAL ORDER
#197 RHYTHM BLUE	SPECIAL ORDER
#302 INCA GOLD BURST	SPECIAL ORDER
#330 IVORY PEARL	SPECIAL ORDER
#331 BLACK PEARL	SPECIAL ORDER
#332 RED PEARL	SPECIAL ORDER
#333 PURPLE METALLIC	SPECIAL ORDER
#334 RED METALLIC	SPECIAL ORDER
#335 BLACK CHERRY	SPECIAL ORDER
NEW #355 *ANTIQUÉ WALNUT	SPECIAL ORDER
NEW #356 TANGERINE DREAM	SPECIAL ORDER
#368 BLACK SILVER BURST	SPECIAL ORDER
#376 ULTRA BLUE FADE	IN STOCK
#393 PURPLE CRAZE II	SPECIAL ORDER

*ANTIQUÉ WALNUT FEATURES MATTE NATURAL MAPLE BASS DRUM HOOPS

FEATURES

- BRL BRIDGE LUGS w/SWIVEL FUNCTION
- LB-200 BRIDGE FT LEG BRACKETS
- LG-200 FLOOR TOM LEGS
- SP-300 SPURS
- MASTERCASED DIE CAST HOOPS
- ALUMINUM OPTIMOUNT TOM HOLDERS
- STAINLESS STEEL TENSION RODS
- MOLDED RUBBER GASKETS
- REMO CLEAR EMPEROR TOM BATTERS
- REMO CLEAR POWERSTROKE3 BD BATTER
- REMO "WINDOW" SNARE BATTER HEAD
- LIFETIME WARRANTY
- CHOICE OF CHROME (C), GOLD PLATED (G) or BLACK CHROME PLATED (B) DRUM HARDWARE BY SPECIAL ORDER*

*NOT AVAILABLE ON REFERENCE BRASS OR STEEL SNARE DRUMS



RFP REFERENCE PURE

SHELL MATERIAL: EVENPLY MAPLE, BIRCH & AFRICAN MAHOGANY
FINISHES: SUPER HIGH GLOSS LACQUER/LACQUER SPARKLES

SHELL PACKS

RFP 924XP **\$5,830**

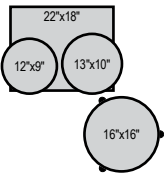

INCLUDES:
RFP 2218BX 22"x18" BASS
RFP 1209T 12"x9" TOM
RFP 1310T 13"x10" TOM
RFP 1616F 16"x16" FLOOR TOM

RFP 924XSP **\$5,830**

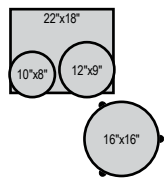

INCLUDES:
RFP 2218BX 22"x18" BASS
RFP 1008T 10"x8" TOM
RFP 1209T 12"x9" TOM
RFP 1616F 16"x16" FLOOR TOM

RFP 904XP **\$5,830**

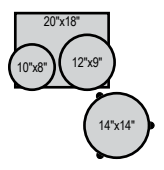

INCLUDES:
RFP 2018BX 20"x18" BASS
RFP 1008T 10"x8" TOM
RFP 1209T 12"x9" TOM
RFP 1414F 14"x14" FLOOR TOM

SHELL COMPOSITION

LEGEND: M= MAPLE; B= BIRCH; MH= AFRICAN MAHOGANY

SNARE DRUMS	PLIES	THICKNESS	OUTSIDE / INSIDE	BEARING EDGE
13"	6	5.4MM	M4 / B2	45°
14"	6	5.4MM	M4 / B2	45°

TOMS	PLIES	THICKNESS	OUTSIDE / INSIDE	BEARING EDGE
8"	6	5.4MM	M4 / B2	ROUNDED 45°
10"	6	5.4MM	M4 / B2	ROUNDED 45°
12"	6	5.4MM	M6	ROUNDED 45°
13"	6	5.4MM	M4 / MH2	ROUNDED 45°
14"	6	5.4MM	M4 / MH2	FULLY ROUNDED
15"	6	5.4MM	M4 / MH2	FULLY ROUNDED
16"	6	5.4MM	M2 / MH4	FULLY ROUNDED

FLOOR TOMS	PLIES	THICKNESS	OUTSIDE / INSIDE	BEARING EDGE
14"	8	7.2MM	M4 / MH4	FULLY ROUNDED
15"	8	7.2MM	M4 / MH4	FULLY ROUNDED
16"	8	7.2MM	M2 / MH6	FULLY ROUNDED
18"	8	7.2MM	M2 / MH6	FULLY ROUNDED

BASS DRUMS	PLIES	THICKNESS	OUTSIDE / INSIDE	BEARING EDGE
18"	6	5.4MM	M2 / MH4	FULLY ROUNDED
20"	6	5.4MM	M2 / MH4	FULLY ROUNDED
22"	8	7.2MM	M2 / MH6	FULLY ROUNDED
24"	8	7.2MM	M2 / MH6	FULLY ROUNDED

COMPONENTS

SNARE DRUMS		
RFP 1365S/C	13"x6.5"	\$980.00
RFP 1450S/C	14"x5"	1,050.00
RFP 1465S/C	14"x6.5"	1,100.00

TOMS		
RFP 0807T/C	8"x7"	\$730.00
RFP 0808T/C	8"x8"	730.00
RFP 1007T/C	10"x7"	850.00
RFP 1008T/C	10"x8"	850.00
RFP 1009T/C	10"x9"	850.00
RFP 1010T/C*	10"x10"	850.00
RFP 1208T/C	12"x8"	880.00
RFP 1209T/C	12"x9"	880.00
RFP 1210T/C	12"x10"	880.00
RFP 1309T/C*	13"x9"	980.00
RFP 1310T/C	13"x10"	980.00
RFP 1311T/C*	13"x11"	980.00
RFP 1410T/C*	14"x10"	1,130.00
RFP 1411T/C	14"x11"	1,130.00
RFP 1412T/C	14"x12"	1,130.00
RFP 1513T/C*	15"x13"	1,180.00
RFP 1514T/C	15"x14"	1,180.00
RFP 1613T/C	16"x13"	1,280.00
RFP 1614T/C	16"x14"	1,280.00

FLOOR TOMS		
RFP 1414F/C	14"x14"	\$1,150.00
RFP 1616F/C	16"x16"	1,265.00
RFP 1816F/C	18"x16"	1,500.00

BASS DRUMS w/BB-3		
RFP 1814BB/C*	18"x14"	\$1,900.00
RFP 1816BB/C*	18"x16"	1,900.00
RFP 2014BB/C*	20"x14"	1,965.00
RFP 2016BB/C*	20"x16"	1,965.00
RFP 2018BB/C*	20"x18"	1,980.00
NEW RFP 2214BB/C*	22"x14"	2,265.00
RFP 2216BB/C*	22"x16"	2,265.00
RFP 2218BB/C*	22"x18"	2,265.00
RFP 2220BB/C*	22"x20"	2,415.00
NEW RFP 2414BB/C*	24"x14"	2,415.00
RFP 2416BB/C*	24"x16"	2,415.00
RFP 2418BB/C*	24"x18"	2,450.00

BASS DRUMS w/O BB-3		
RFP 1814BX/C*	18"x14"	\$1,900.00
RFP 1816BX/C*	18"x16"	1,900.00
RFP 2014BX/C*	20"x14"	1,965.00
RFP 2016BX/C*	20"x16"	1,965.00
RFP 2018BX/C*	20"x18"	1,980.00
NEW RFP 2214BX/C	22"x14"	2,265.00
RFP 2216BX/C	22"x16"	2,265.00
RFP 2218BX/C	22"x18"	2,265.00
RFP 2220BX/C*	22"x20"	2,415.00
NEW RFP 2414BX/C*	24"x14"	2,415.00
RFP 2416BX/C*	24"x16"	2,415.00
RFP 2418BX/C	24"x18"	2,450.00

GONG DRUM w/ 2 X BB-3		
RFP 2014G/C*	20"x14"	\$1,565.00

*SPECIAL ORDER ONLY
PLEASE ALLOW 3 TO 5 MONTHS
FOR DELIVERY

FINISHES

LACQUER w/CHROME PLATED DRUM HARDWARE		
#100 WINE RED		SPECIAL ORDER
#102 NATURAL MAPLE		IN STOCK
#103 PIANO BLACK		IN STOCK
#109 ARCTIC WHITE		SPECIAL ORDER
#126 EMERALD MIST		SPECIAL ORDER
#128 VINTAGE SUNBURST		SPECIAL ORDER
#142 ROOTBEER FADE		SPECIAL ORDER
#143 TWILIGHT FADE		SPECIAL ORDER
#148 EMERALD FADE		SPECIAL ORDER
#151 PLATINUM MIST		SPECIAL ORDER
#152 ANTIQUE GOLD		SPECIAL ORDER
#153 SUNRISE FADE		SPECIAL ORDER
#154 MIDNIGHT FADE		SPECIAL ORDER
#155 SCARLET FADE		SPECIAL ORDER
#197 RHYTHM BLUE		SPECIAL ORDER
#302 INCA GOLD BURST		SPECIAL ORDER
#330 IVORY PEARL		SPECIAL ORDER
#331 BLACK PEARL		SPECIAL ORDER
#332 RED PEARL		SPECIAL ORDER
#333 PURPLE METALLIC		SPECIAL ORDER
#334 RED METALLIC		SPECIAL ORDER
#335 BLACK CHERRY		SPECIAL ORDER
#342 VINTAGE TOBACCO BURST		SPECIAL ORDER
NEW #356 TANGERINE DREAM		SPECIAL ORDER
NEW #355 *ANTIQUE WALNUT		SPECIAL ORDER
#368 BLACK SILVER BURST		SPECIAL ORDER
#377 SCARLET SPARKLE BURST		IN STOCK
#393 PURPLE CRAZE II		SPECIAL ORDER

*ANTIQUÉ WALNUT FEATURES MATTE NATURAL MAPLE BASS DRUM HOOPS

FEATURES

- LOW MASS EVEN-PLY SHELLS
- LOW MASS STL SWIVEL TUBE LUGS
- LOW MASS FAT TONE HOOPS
- LB-200 BRIDGE FT LEG BRACKETS
- LG-200 FLOOR TOM LEGS
- SP-300 SPURS
- ALUMINUM OPTIMOUNT TOM HOLDERS
- STAINLESS STEEL TENSION RODS
- MOLDED RUBBER GASKETS
- REMO CLEAR EMPEROR TOM BATTERS
- REMO CLEAR POWERSTROKE3 BD BATTER
- REMO "WINDOW" SNARE BATTER HEAD
- LIFETIME WARRANTY



MCX MASTERS MAPLE

SHELL MATERIAL: 6 PLY 7.5MM 100% MAPLE
FINISH: ARTISAN II & SUPER HIGH GLOSS LACQUER

SHELL PACKS

MCX 924XP/C \$2,999

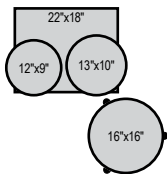

INCLUDES:
MCX 2218BX 22"x18" BASS
MCX 1209T 12"x9" TOM
MCX 1310T 13"x10" TOM
MCX 1616F 16"x16" FLOOR TOM

MCX 924XSP/C \$2,999

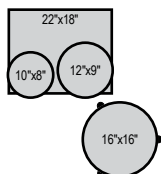

INCLUDES:
MCX 2218BX 22"x18" BASS
MCX 1008T 10"x8" TOM
MCX 1209T 12"x9" TOM
MCX 1616F 16"x16" FLOOR TOM

MCX 904XP/C \$2,999

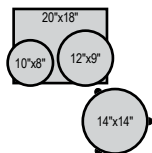

INCLUDES:
MCX 2018BX 20"x18" BASS
MCX 1008T 10"x8" TOM
MCX 1209T 12"x9" TOM
MCX 1414F 14"x14" FLOOR TOM

COMPONENTS

SNARE DRUMS

MCX 1455S/C	14"x5.5"	\$640.00
MCX 1465S/C	14"x6.5"	680.00

TOMS w/OPTIMOUNT

MCX 0807T/C	8"x7"	\$490.00
MCX 0808T/C	8"x8"	490.00
MCX 1007T/C	10"x7"	590.00
MCX 1008T/C	10"x8"	590.00
MCX 1009T/C	10"x9"	590.00
MCX 1010T/C*	10"x10"	590.00
MCX 1208T/C*	12"x8"	640.00
MCX 1209T/C	12"x9"	640.00
MCX 1210T/C	12"x10"	640.00
MCX 1309T/C*	13"x9"	690.00
MCX 1310T/C*	13"x10"	690.00
MCX 1311T/C	13"x11"	690.00
MCX 1411T/C	14"x11"	790.00
MCX 1412T/C	14"x12"	790.00
MCX 1513T/C*	15"x13"	850.00
MCX 1514T/C	15"x14"	850.00
MCX 1613T/C	16"x13"	940.00
MCX 1614T/C	16"x14"	940.00

FLOOR TOMS

MCX 1414F/C	14"x14"	\$900.00
MCX 1616F/C	16"x16"	1,000.00
MCX 1816F/C	18"x16"	1,200.00

BASS DRUMS w/o BB-3

MCX 1814BX/C*	18"x14"	\$1,540.00
MCX 1816BX/C*	18"x16"	1,540.00
MCX 2016BX/C	20"x16"	1,600.00
MCX 2018BX/C	20"x18"	1,600.00
MCX 2216BX/C	22"x16"	1,700.00
MCX 2218BX/C	22"x18"	1,700.00
MCX 2416BX/C*	24"x16"	1,800.00
MCX 2418BX/C	24"x18"	1,800.00

*SPECIAL ORDER ONLY
PLEASE ALLOW 3-5 MONTHS FOR DELIVERY

FINISHES

SUPER HIGH-GLOSS & ARTISAN II LACQUER

#103 PIANO BLACK	w/CHROME DRUM HW
#388 SHAMROCK GREEN	w/CHROME DRUM HW
#800 QUILTED BUBINGA SUNBURST	w/CHROME DRUM HW
#807 NATURAL BIRDSEYE MAPLE	w/CHROME DRUM HW
#810 ASH FADE TAMO	w/CHROME DRUM HW

FEATURES

- ARTISAN II LACQUER FINISHES
- 100% MAPLE SHELLS
- 100% MAPLE BASS DRUM HOOPS
- MASTERS BRIDGE LUGS
- MASTERCASED DIE CAST HOOPS ON TOMS
- OPTIMOUNT TOM HOLDERS
- MOLDED RUBBER GASKETS
- REMO HEADS
- LIFETIME WARRANTY



BCX MASTERS BIRCH

SHELL MATERIAL: 6 PLY 7.5MM 100% BIRCH
FINISH: ARTISAN II & SUPER HIGH GLOSS LACQUER

SHELL PACKS

BCX 924XP/C \$2,499

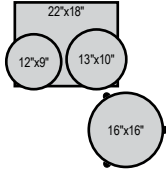

INCLUDES:
BCX 2218BX 22"x18" BASS
BCX 1209T 12"x9" TOM
BCX 1310T 13"x10" TOM
BCX 1616F 16"x16" FLOOR TOM

BCX 924XSP/C \$2,499

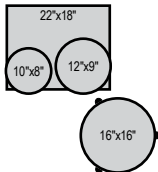

INCLUDES:
BCX 2218BX 22"x18" BASS
BCX 1008T 10"x8" TOM
BCX 1209T 12"x9" TOM
BCX 1616F 16"x16" FLOOR TOM

BCX 904XP/C \$2,499

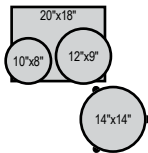

INCLUDES:
BCX 2018BX 20"x18" BASS
BCX 1008T 10"x8" TOM
BCX 1209T 12"x9" TOM
BCX 1414F 14"x14" FLOOR TOM

COMPONENTS

SNARE DRUMS

BCX 1455S/C	14"x5.5"	\$500.00
BCX 1465S/C	14"x6.5"	530.00

TOMS w/OPTIMOUNT

BCX 0807T/C	8"x7"	\$430.00
BCX 0808T/C	8"x8"	430.00
BCX 1007T/C	10"x7"	465.00
BCX 1008T/C	10"x8"	465.00
BCX 1009T/C	10"x9"	465.00
BCX 1010T/C*	10"x10"	465.00
BCX 1208T/C*	12"x8"	500.00
BCX 1209T/C	12"x9"	500.00
BCX 1210T/C	12"x10"	500.00
BCX 1309T/C*	13"x9"	550.00
BCX 1310T/C*	13"x10"	550.00
BCX 1311T/C	13"x11"	550.00
BCX 1411T/C	14"x11"	600.00
BCX 1412T/C	14"x12"	600.00
BCX 1513T/C*	15"x13"	650.00
BCX 1514T/C	15"x14"	650.00
BCX 1613T/C	16"x13"	730.00
BCX 1614T/C	16"x14"	730.00

FLOOR TOMS

BCX 1414F/C	14"x14"	\$680.00
BCX 1616F/C	16"x16"	765.00
BCX 1816F/C	18"x16"	900.00

BASS DRUMS w/o BB-3

BCX 1814BX/C*	18"x14"	\$1,130.00
BCX 1816BX/C*	18"x16"	1,130.00
BCX 2016BX/C	20"x16"	1,165.00
BCX 2018BX/C	20"x18"	1,165.00
BCX 2216BX/C	22"x16"	1,230.00
BCX 2218BX/C	22"x18"	1,230.00
BCX 2416BX/C*	24"x16"	1,300.00
BCX 2418BX/C	24"x18"	1,300.00

*SPECIAL ORDER ONLY
PLEASE ALLOW 3-5 MONTHS FOR DELIVERY

FINISHES

SUPER HIGH-GLOSS & ARTISAN II LACQUER

#357 GOLDEN BRONZE GLITTER	w/CHROME DRUM HW
#358 SILVER GLITTER	w/CHROME DRUM HW
#818 LAVA BUBINGA	w/CHROME DRUM HW

FEATURES

- ARTISAN II LACQUER FINISHES
- 100% BIRCH SHELLS
- 100% BIRCH BASS DRUM HOOPS
- MASTERS BRIDGE LUGS
- MASTERCAST DIE CAST HOOPS ON TOMS
- OPTIMOUNT TOM HOLDERS
- MOLDED RUBBER GASKETS
- REMO HEADS
- LIFETIME WARRANTY



SSC SESSION STUDIO CLASSIC

SHELL MATERIAL: 6 PLY 7.5MM BIRCH/KAPUR SHELLS
FINISH: SUPER HIGH GLOSS LACQUER

SHELL PACKS

SSC 924XUP/C \$1,999

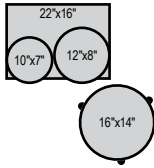

INCLUDES:
SSC 2216BX 22"x16" BASS
SSC 1007T 10"x7" TOM
SSC 1208T 12"x8" TOM
SSC 1614F 16"x14" FLOOR TOM

SSC 944XUP/C \$1,999

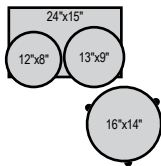

INCLUDES:
SSC 2415BX 24"x15" BASS
SSC 1208T 12"x8" TOM
SSC 1309T 13"x9" TOM
SSC 1614F 16"x14" FLOOR TOM

SSC 904XUP/C \$1,999

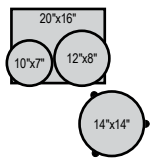

INCLUDES:
SSC 2016BX 20"x16" BASS
SSC 1007T 10"x7" TOM
SSC 1208T 12"x8" TOM
SSC 1414F 14"x14" FLOOR TOM

COMPONENTS

SNARE DRUMS

SSC 1455S/C	14"x5.5"	\$350.00
SSC 1465S/C	14"x6.5"	380.00

TOMS w/OPTIMOUNT

SSC 1007T/C	10"x7"	\$380.00
SSC 1208T/C	12"x8"	415.00
SSC 1309T/C	13"x9"	430.00
SSC 1410T/C	14"x10"	465.00

FLOOR TOMS

SSC 1414F/C	14"x14"	\$550.00
SSC 1614F/C	16"x14"	615.00
SSC 1616F/C*	16"x16"	615.00
SSC 1816F/C*	18"x16"	715.00

BASS DRUMS w/o BB-3

SSC 2016BX/C	20"x16"	\$1,080.00
SSC 2216BX/C	22"x16"	1,180.00
SSC 2415BX/C	24"x15"	1,250.00

*SPECIAL ORDER - PLEASE ALLOW 3 TO 5 MONTHS FOR DELIVERY

FINISHES

SUPER HIGH-GLOSS LACQUER

#103 PIANO BLACK	w/CHROME DRUM HW
#106 ANTIQUE IVORY	w/CHROME DRUM HW
#110 SEQUOIA RED	w/CHROME DRUM HW
#113 SHEER BLUE	w/CHROME DRUM HW
NEW #361 VINTAGE COPPER SPARKLE	w/CHROME DRUM HW
#389 MATTE LIQUID AMBER	w/CHROME DRUM HW

FEATURES

- 6 PLY BIRCH/KAPUR SHELLS
- WOOD BASS DRUM HOOPS w/MATCHING FINISH
- RECESSED BD CLAWS w/RUBBER LINING
- REMO SNARE DRUM HEADS
- REMO PINSTRIPE TOM BATTER/CLEAR RESO HEADS
- REMO POWERSTROKE BASS DRUM HEADS
- RL-10/20 SESSION LUGS
- LB/LG-40 MASTERS FLOOR TOM BRACKETS & LEGS
- OPTIMOUNT TOM HOLDERS
- BEAUTIFUL SUPER HIGH-GLOSS LACQUER FINISHES
- LIFETIME WARRANTY



SUGGESTED HARDWARE PACK

HWP-930 930 SERIES w/UNILOCK TILTERS **\$770**

NEW LIMITED EDITION FW WOOD FIBERGLASS

SHELL MATERIAL: 6 PLY 7.5MM POPLAR/KAPUR/FIBERGLASS SHELLS
FINISHES: HIGH GLOSS AND SATIN LACQUER

SHELL PACKS

FW 923XP/C **\$1,759**

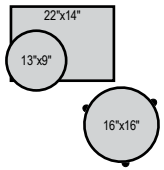

INCLUDES:
FW 2214BX 22"x14" BASS
FW 1309T 13"x9" TOM
FW 1616F 16"x16" FLOOR TOM

FW 943XP/C **\$1,799**

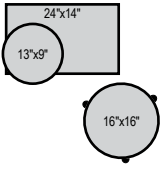

INCLUDES:
FW 2414BX 24"x14" BASS
FW 1309T 13"x9" TOM
FW 1616T 16"x16" FLOOR TOM

FW 903XP/C **\$1,665**

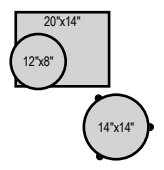

INCLUDES:
FW 2014BX 20"x14" BASS
FW 1208T 12"x8" TOM
FW 1414F 14"x14" FLOOR TOM

COMPONENTS

TOMS w/OPTIMOUNT		
FW 1007T/C*	10"x7"	\$400.00
FW 1208T/C*	12"x8"	430.00
FW 1309T/C*	13"x9"	460.00

FLOOR TOMS		
FW 1414F/C*	14"x14"	\$590.00
FW 1616F/C*	16"x16"	660.00
FW 1816F/C*	18"x16"	790.00

BASS DRUMS w/o BB-3 BRACKET		
FW 2014BX/C*	20"x14"	\$1,100.00
FW 2214BX/C*	22"x14"	1,180.00
FW 2414BX/C*	24"x14"	1,260.00

*SPECIAL ORDER - PLEASE ALLOW 3 TO 5 MONTHS FOR DELIVERY

FINISHES

PRO LACQUER

#103	PIANO BLACK	w/CHROME DRUM HW
#151	PLATINUM MIST	w/CHROME DRUM HW
#152	ANTIQUE GOLD	w/CHROME DRUM HW
<i>NEW</i> #327	SATIN COCOA BURST	w/CHROME DRUM HW

FEATURES

- 6 PLY POPLAR/KAPUR/FIBERGLASS SHELLS
- WOOD BASS DRUM HOOPS w/MATCHING FINISH
- RECESSED BD CLAWS w/RUBBER LINING
- REMO SNARE DRUM HEADS
- REMO PINSTRIPE TOM BATTER/CLEAR RESO HEADS
- REMO POWERSTROKE BASS DRUM HEADS (WHITE COATED VENTED FRONT LOGO HEAD)
- RL-10/20 SESSION LUGS
- LB/LG-40 MASTERS FLOOR TOM BRACKETS & LEGS
- OPTIMOUNT TOM HOLDERS
- BEAUTIFUL SUPER HIGH-GLOSS & MATTE LACQUER FINISHES
- LIFETIME WARRANTY



SUGGESTED HARDWARE PACK

HWP-930 930 SERIES w/UNILOCK TILTERS **\$770**

CRB CRYSTAL BEAT

SHELL MATERIAL: SEAMLESS ACRYLIC SHELLS
FINISH: CRYSTAL CLEAR

SHELL PACKS

CRB 524P/C **\$1,799**

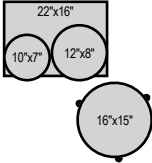

INCLUDES:
CRB 2216BX 22"x16" BASS
CRB 1007T 10"x7" TOM
CRB 1208T 12"x8" TOM
CRB 1615F 16"x15" FLOOR TOM

CRB 524FP/C **\$1,999**

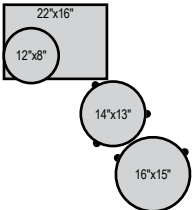

INCLUDES:
CRB 2216BX 22"x16" BASS
CRB 1208T 12"x8" TOM
CRB 1413F 14"x13" FLOOR TOM
CRB 1615F 16"x15" FLOOR TOM

CRB 525FP/C **\$2,165**

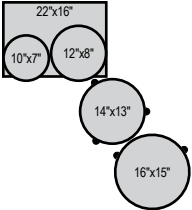

INCLUDES:
CRB 2216BX 22"x16" BASS
CRB 1007T 10"x7" TOM
CRB 1208T 12"x8" TOM
CRB 1413F 14"x13" FLOOR TOM
CRB 1615F 16"x15" FLOOR TOM

CRB 503P/C **\$1,499**

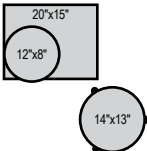

INCLUDES:
CRB 2015BX 20"x15" BASS
CRB 1208T 12"x8" TOM
CRB 1413F 14"x13" FLOOR TOM

SUGGESTED HARDWARE PACK

HWP-930 930 SERIES w/UNILOCK TILTERS **\$770**

COMPONENTS

ACRYLIC SHELL FREE FLOATING SNARE DRUMS

CRB 1435/C*	14"x3.5"	TBA
CRB 1450/C	14"x5"	\$799.00
CRB 1465/C	14"x6.5"	829.00
CRB 1480/C*	14"x8"	TBA

*SPECIAL ORDER ONLY - PLEASE ALLOW 3 TO 5 MONTHS FOR DELIVERY.

ACRYLIC SHELLS FOR FREE FLOATING SNARE DRUM CHASSIS

*FITS ALL CURRENT AND PAST MODELS

	Drum Size	
CRB 1435SO*	14"x3.5"	TBA
CRB 1450SO	14"x5"	\$180.00
CRB 1465SO	14"x6.5"	199.00
CRB 1480SO*	14"x8"	TBA

*SPECIAL ORDER ONLY - PLEASE ALLOW 3 TO 5 MONTHS FOR DELIVERY.

TOMS w/OPTIMOUNT

CRB 0807T/C	8"x7"	\$295.00
CRB 1007T/C	10"x7"	325.00
CRB 1208T/C	12"x8"	375.00
CRB 1309T/C	13"x9"	395.00

FLOOR TOMS

CRB 1413F/C	14"x13"	\$420.00
CRB 1615F/C	16"x15"	485.00
CRB 1816F/C	18"x16"	510.00

BASS DRUMS w/O BB-3

CRB 2015BX/C	20"x15"	\$770.00
CRB 2216BX/C	22"x16"	810.00

FINISHES

CRYSTAL CLEAR

#730	ULTRA CLEAR	w/CHROME DRUM HW
#731	RUBY RED	w/CHROME DRUM HW
#732	TANGERINE GLASS	w/CHROME DRUM HW

FEATURES

- SEAMLESS ACRYLIC SHELLS
- 6MM TOM AND SNARE DRUM SHELLS
- 7MM BASS DRUM SHELLS
- ACRYLIC BASS DRUM HOOPS w/MATCHING FINISH
- RECESSED BASS DRUM CLAWS w/RUBBER LINING
- 1.2MM TRIPLE FLANGED HOOPS
- 2 PLY CLEAR TOM BATTER HEADS
- 1 PLY CLEAR TOM RESO HEADS
- 1 PLY CLEAR BASS DRUM HEADS w/SELF-MUFFLING RING
- OPTIMOUNT SUSPENSION SYSTEM
- AIR SUSPENSION FLOOR TOM FEET
- MOLDED RUBBER GASKETS
- TELESCOPING SPURS w/RUBBER OR SPIKE TIP
- BEAUTIFUL CRYSTAL CLEAR FINISHES
- LIMITED 2 YEAR WARRANTY

VBL VISION BIRCH LACQUER

SHELL MATERIAL: 6 PLY 7.5MM 100% BIRCH
FINISH: SUPER HIGH GLOSS LACQUER

SETS & SHELL PACKS

VBL 925/C SHELL PACK & 930 HARDWARE **\$1,899**
VBL 925P/C SHELL PACK **1,359**

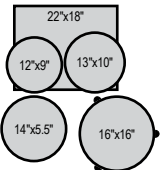

SHELL PACK:			930 HARDWARE:
VBL 2218B/C	22"x18"	BASS	BC-930 BOOM STAND
VBL 1209T/C	12"x9"	TOM	C-930 CYMBAL STAND
VBL 1310T/C	13"x10"	TOM	H-930 HI-HAT STAND
VBL 1616F/C	16"x16"	FLOOR TOM	S-930 SNARE STAND
SS 1455S/C	14"x5.5"	SENSITONE	P-930 PEDAL
TH-900I	UNI-LOCK	TOM ARMS (2)	

VBL 925S/C SHELL PACK & 930 HARDWARE **\$1,899**
VBL 925SP/C SHELL PACK **1,359**

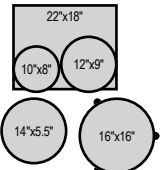

SHELL PACK:			930 HARDWARE:
VBL 2218B/C	22"x18"	BASS	BC-930 BOOM STAND
VBL 1008T/C	10"x8"	TOM	C-930 CYMBAL STAND
VBL 1209T/C	12"x9"	TOM	H-930 HI-HAT STAND
VBL 1616F/C	16"x16"	FLOOR TOM	S-930 SNARE STAND
SS 1455S/C	14"x5.5"	SENSITONE	P-930 PEDAL
TH-900I	UNI-LOCK	TOM ARMS (2)	

VBL 905/C SHELL PACK & 930 HARDWARE **\$1,899**
VBL 905P/C SHELL PACK **1,359**

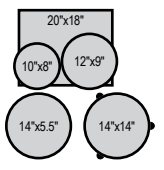

SHELL PACK:			930 HARDWARE:
VBL 2018B/C	20"x18"	BASS	BC-930 BOOM STAND
VBL 1008T/C	10"x8"	TOM	C-930 CYMBAL STAND
VBL 1209T/C	12"x9"	TOM	H-930 HI-HAT STAND
VBL 1414F/C	14"x14"	FLOOR TOM	S-930 SNARE STAND
SS 1455S/C	14"x5.5"	SENSITONE	P-930 PEDAL
TH-900I	UNI-LOCK	TOM ARMS (2)	

SUGGESTED HARDWARE PACK

HWP-930 930 SERIES w/UNILOCK TILTERS **\$770**

COMPONENTS

SENSITONE SNARE DRUM w/CHROME FINISH		
SS 1455S/C	14"x5.5"	\$250.00

TOMS w/I.S.S.		
VBL 0807T/C	8"x7"	\$250.00
VBL 1008T/C	10"x8"	265.00
VBL 1209T/C	12"x9"	280.00
VBL 1310T/C	13"x10"	300.00
VBL 1411T/C	14"x11"	330.00
VBL 1613T/C	16"x13"	415.00

FLOOR TOMS		
VBL 1414F/C	14"x14"	\$380.00
VBL 1616F/C	16"x16"	465.00
VBL 1816F/C	18"x16"	530.00

BASS DRUMS w/BB-300 BRACKET		
VBL 2018B/C	20"x18"	\$780.00
VBL 2218B/C	22"x18"	830.00
VBL 2418B/C	24"x18"	915.00

FINISHES

HIGH GLOSS LACQUER		
#230 CLEAR BIRCH	w/CHROME DRUM HARDWARE	
#232 RUBY FADE	w/CHROME DRUM HARDWARE	
#239 GRAPHITE	w/CHROME DRUM HARDWARE	
#243 PRUSSIAN BLUE	w/CHROME DRUM HARDWARE	
#244 NATURAL BLACK BURST	w/CHROME DRUM HARDWARE	

FEATURES

- 6 PLY 7.5MM 100% BIRCH SHELLS
- STEEL SENSITONE SNARE DRUM w/CHROME FINISH
- WOOD BASS DRUM HOOPS w/MATCHING FINISH
- 930 SERIES HARDWARE
- REMO SNARE DRUM HEADS
- REMO PINSTRIPE TOM BATTER/CLEAR RESO HEADS
- REMO POWERSTROKE BASS DRUM HEADS
- REFERENCE-LOOK BRIDGE LUGS w/RUBBER GASKETS
- REFERENCE-LOOK FLOOR TOM LEG BRACKETS & LEGS
- REFERENCE-LOOK RECESSED BD CLAWS w/RUBBER LINING
- BRIDGE-TYPE BASS BRACKET
- 900 SERIES UNI-LOCK (INFINITELY ADJUSTABLE) TOM HOLDERS
- I.S.S. TOM MOUNTING SYSTEM
- BEAUTIFUL SUPER HIGH-GLOSS LACQUER FINISHES
- LIFETIME WARRANTY



EXL EXPORT LACQUER

SHELL MATERIAL: 6 PLY 7.5MM POPLAR / ASIAN MAHOGANY
FINISH: HIGH GLOSS LACQUER

SETS & ADD-ON PACKS

NEW

EXL 725/C 5 PC. SET w/830 HW **\$1,249**

EXL 725P/C SHELL PACK **799**

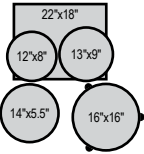

DRUMS

EXL 2218B/C 22"x18" BASS
EXL 1208T/C 12"x8" TOM
EXL 1309T/C 13"x9" TOM
EXL 1616F/C 16"x16" FLOOR TOM
EXL 1455S/C 14"x5.5" SNARE
TH-701 GEAR TOM ARMS x 2

830 HARDWARE

BC-830 BOOM STAND
C-830 CYMBAL STAND
H-830 HI-HAT STAND
S-830 SNARE STAND
P-930 PEDAL

NEW

EXL 725/C 5 PC. SET w/830 HW **\$1,249**

EXL 725SP/C SHELL PACK **799**

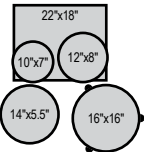

DRUMS

EXL 2218B/C 22"x18" BASS
EXL 1007T/C 10"x7" TOM
EXL 1208T/C 12"x8" TOM
EXL 1616F/C 16"x16" FLOOR TOM
EXL 1455S/C 14"x5.5" SNARE
TH-701 GEAR TOM ARMS x 2

830 HARDWARE

BC-830 BOOM STAND
C-830 CYMBAL STAND
H-830 HI-HAT STAND
S-830 SNARE STAND
P-930 PEDAL

NEW

EXL 705/C 5 PC. SET w/830 HW **\$1,249**

EXL 705P/C SHELL PACK **799**

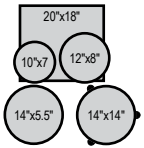

DRUMS

EXL 2018B/C 20"x18" BASS
EXL 1007T/C 10"x7" TOM
EXL 1208T/C 12"x8" TOM
EXL 1414F/C 14"x14" FLOOR TOM
EXL 1455S/C 14"x5.5" SNARE
TH-701 GEAR TOM ARMS x 2

830 HARDWARE

BC-830 BOOM STAND
C-830 CYMBAL STAND
H-830 HI-HAT STAND
S-830 SNARE STAND
P-930 PEDAL

ADD-ON PACKS

EXL 8P/C EXL-0807T/C 8"x7" w/TH-70S & ADP-20 **\$180**

EXL 10P/C EXL-1007T/C 10"x7" w/TH-70S & ADP-20 **200**

COMPONENTS

SNARE DRUM

EXL 1455S/C | 14"x5.5" | **\$200.00**

TOMS w/I.S.S.

EXL 1208T/C | 12"x8" | **\$180.00**

EXL 1309T/C | 13"x9" | **200.00**

FLOOR TOMS

EXL 1414F/C | 14"x14" | **\$265.00**

EXL 1616F/C | 16"x16" | **300.00**

EXL 1816F/C | 18"x16" | **350.00**

BASS DRUMS w/BB-70

EXL 2018B/C | 20"x18" | **\$465.00**

EXL 2218B/C | 22"x18" | **500.00**

EXL 2418B/C | 24"x18" | **530.00**

FINISHES

HIGH GLOSS LACQUER FINISHES

#246 NATURAL CHERRY | w/CHROME DRUM HW

#248 BLACK SMOKE | w/CHROME DRUM HW

#249 HONEY AMBER | w/CHROME DRUM HW

NEW #255 NIGHTSHADE LACQUER | w/CHROME DRUM HW

FEATURES

- 6 PLY 7.5MM POPLAR/ASIAN MAHOGANY SHELLS
- OPTI-LOC SUSPENSION SYSTEM
- REMO SNARE DRUM HEADS
- REMO CLEAR TOM HEADS
- REMO POWERSTROKE BASS DRUM HEADS
- MATCHING WOOD SNARE DRUM
- WOOD BASS DRUM HOOPS
- LIFETIME WARRANTY



EXX EXPORT

SHELL MATERIAL: 6 PLY 7.5 POPLAR/ASIAN MAHOGANY
FINISH: PEARL EXCLUSIVE COVERED FINISHES

SETS

EXX 725/C 5 PC. SET w/830 HARDWARE \$1,099

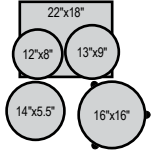

DRUMS:		830 HARDWARE:	
EXX 2218B/C	22"x18" BASS	BC-830	BOOM STAND
EXX 1208T/C	12"x8" TOM	C-830	CYMBAL STAND
EXX 1309T/C	13"x9" TOM	H-830	HI-HAT STAND
EXX 1616F/C	16"x16" FLOOR TOM	S-830	SNARE STAND
EXX 1455S/C	14"x5.5" SNARE	P-930	PEDAL
TH-701	GEAR TOM ARMS x 2		

EXX 725S/C 5 PC. SET w/830 HARDWARE \$1,099

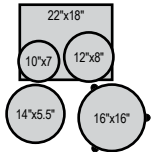

DRUMS:		830 HARDWARE:	
EXX 2218B/C	22"x18" BASS	BC-830	BOOM STAND
EXX 1007T/C	10"x7" TOM	C-830	CYMBAL STAND
EXX 1208T/C	12"x8" TOM	H-830	HI-HAT STAND
EXX 1616F/C	16"x16" FLOOR TOM	S-830	SNARE STAND
EXX 1455S/C	14"x5.5" SNARE	P-930	PEDAL
TH-701	GEAR TOM ARMS x 2		

EXX 705/C 5 PC. SET w/830 HARDWARE \$1,099

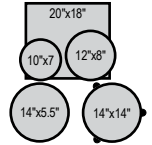

DRUMS:		830 HARDWARE:	
EXX 2018B/C	20"x18" BASS	BC-830	BOOM STAND
EXX 1007T/C	10"x7" TOM	C-830	CYMBAL STAND
EXX 1208T/C	12"x8" TOM	H-830	HI-HAT STAND
EXX 1414F/C	14"x14" FLOOR TOM	S-830	SNARE STAND
EXX 1455S/C	14"x5.5" SNARE	P-930	PEDAL
TH-701	GEAR TOM ARMS x 2		

COMPONENTS

SNARE DRUM		
EXX 1455S/C	14"x5.5"	\$180.00

TOMS w/OPTI-LOC		
EXX 1208T/C	12"x8"	\$170.00
EXX 1309T/C	13"x9"	180.00

FLOOR TOMS		
EXX 1414F/C	14"x14"	\$220.00
EXX 1616F/C	16"x16"	250.00
EXX 1816F/C	18"x16"	280.00

BASS DRUMS w/BB-70		
EXX 2018B/C	20"x18"	\$420.00
EXX 2218B/C	22"x18"	450.00
EXX 2418B/C	24"x18"	480.00

FINISHES

COVERED		
#21	SMOKEY CHROME	w/CHROME DRUM HW
#31	JET BLACK	w/CHROME DRUM HW
#33	PURE WHITE	w/CHROME DRUM HW
#91	RED WINE	w/CHROME DRUM HW
#702	ELECTRIC BLUE SPARKLE	w/CHROME DRUM HW
<i>NEW</i> #708	GRINDSTONE SPARKLE	w/CHROME DRUM HW

FEATURES

- 6 PLY 7.5MM POPLAR / ASIAN MAHOGANY SHELLS
- OPTI-LOC SUSPENSION TOM HOLDER
- MATCHING WOOD SNARE DRUM
- WOOD BASS DRUM HOOPS
- REMO SNARE DRUM HEADS
- REMO CLEAR TOM HEADS
- REMO POWERSTROKE BASS DRUM HEADS
- LIFETIME WARRANTY



ADD-ON PACKS

EXX 8P/C	EXX-0807T/C 8"x7" w/TH-70S & ADP-20	\$170
EXX 10P/C	EXX-1007T/C 10"x7" w/TH-70S & ADP-20	180

RS ROADSHOW

SHELL MATERIAL: 9 PLY 7MM POPLAR
FINISH: PEARL EXCLUSIVE COVERED FINISHES

COMPLETE SETS w/CYMBALS

FINISHES

EXCLUSIVE COVERED FINISHES

#31	JET BLACK	w/CHROME DRUM HW
#91	WINE RED	w/CHROME DRUM HW
#706	CHARCOAL METALLIC	w/CHROME DRUM HW
#707	BRONZE METALLIC	w/CHROME DRUM HW

FEATURES

- 9 PLY 7MM POPLAR SHELLS
- DOUBLE-BRACED HARDWARE
- 1.2MM TRIPLE FLANGED HOOPS
- 1 PLY COATED SNARE DRUM HEAD
- 1 PLY CLEAR TOM HEADS
- 1 PLY CLEAR BASS DRUM HEADS w/SELF-MUFFLING RING
- MATCHING WOOD SNARE DRUM
- 16" CRASH-RIDE CYMBAL
- 14" HYBRID HI-HATS
- MAPLE DRUM STICKS (2 PR)
- PROFESSIONAL STICK BAG
- PEARL DRUM POSTER
- LIMITED 2 YEAR WARRANTY

RS 525SC/C

5 PC. SET **\$749**

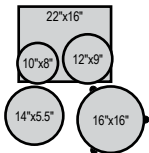

DRUMS

RS 2216B/C	22"x16"	BASS
RS 1008T/C	10"x8"	TOM
RS 1209T/C	12"x9"	TOM
RS 1616F/C	16"x16"	FLOOR TOM
RS 1455S/C	14"x5.5"	SNARE

HARDWARE & CYMBALS

CYMBAL STAND
HI-HAT STAND
SNARE STAND
PEDAL
THRONE
TOM HOLDERS x 2
16" BRASS CRASH-RIDE
14" HYBRID HI-HATS
DRUM STICKS (2PR)
STICK BAG

RS 525WFC/C

5 PC. SET **\$839**

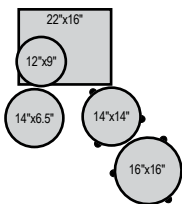

DRUMS

RS 2216B/C	22"x16"	BASS
RS 1209T/C	12"x9"	TOM
RS 1414F/C	14"x14"	FLOOR TOM
RS 1616F/C	16"x16"	FLOOR TOM
RS 1465S/C	14"x6.5"	SNARE

HARDWARE & CYMBALS

CYMBAL STAND
HI-HAT STAND
SNARE STAND x 2
PEDAL
THRONE
16" BRASS CRASH-RIDE
14" HYBRID HI-HATS
DRUM STICKS (2PR)
STICK BAG

RS 505C/C

5 PC. SET **\$749**

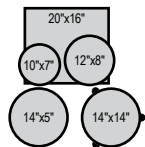

DRUMS

RS 2016B/C	20"x16"	BASS
RS 1007T/C	10"x7"	TOM
RS 1208T/C	12"x8"	TOM
RS 1414F/C	14"x14"	FLOOR TOM
RS 1450S/C	14"x5"	SNARE

HARDWARE & CYMBALS

CYMBAL STAND
HI-HAT STAND
SNARE STAND
PEDAL
THRONE
TOM HOLDERS x 2
16" BRASS CRASH-RIDE
14" HYBRID HI-HATS
DRUM STICKS (2PR)
STICK BAG

RS 584C/C

4 PC. SET **\$649**

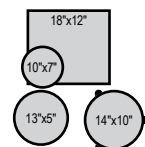

DRUMS

RS 1812B/C	18"x12"	BASS
RS 1007T/C	10"x7"	TOM
RS 1410F/C	14"x14"	FLOOR TOM
RS 1350S/C	13"x5"	SNARE

HARDWARE & CYMBALS

BOOM CYMBAL HOLDER
HI-HAT STAND
SNARE STAND
PEDAL
THRONE
TOM HOLDER
16" BRASS CRASH-RIDE
14" HYBRID HI-HATS
DRUM STICKS (2PR)
STICK BAG

RT RHYTHM TRAVELER

RT 705HBCMH 31 **\$832.00**

20"x8" BASS
10"x5" TOM
12"x5" TOM
14"x5" TOM
13"x5" SNARE
16" BRASS CYMBAL
13" BRASS HI-HATS (PR.)
PLASTIC RIDE CYMBAL
13" PLASTIC HI-HATS (PR.)
CYMBAL PADS x 2 / HH PAD x 1
CYMBAL STAND
SNARE STAND
HI-HAT STAND
PEDAL
TOM ARMS
SHORT TOM ARM w/CLAMP
PLASTIC & MESH HEADS
#31 JET BLACK FINISH



RHYTHM TRAVELER POD

RT 565 **\$832.00**

16"x13" BASS
8"x3.5" TOM
10"x4" TOM
12"x5" TOM
12"x5" SNARE
13" BRASS CYMBAL
13" BRASS HI-HATS (PR.)
MESH HEADS
2-PLY PROTONE HEADS
CYMBAL HOLDER
HI-HAT STAND
PEDAL
TOM ARMS
#31 JET BLACK FINISH
#33 PURE WHITE FINISH
#91 RED WINE FINISH



ROCKET TOMS ALUMINUM SHELLS

AL-0612	6"x12"	\$179.00
AL-0615	6"x15"	209.00
AL-0618	6"x18"	219.00
AL-0621	6"x21"	239.00
ALX-1215	12" & 15" w/T-890	599.00
ALX-1821	18" & 21" w/T-890	639.00

COLORS: #103 PIANO BLACK & #109 ARCTIC WHITE



EPEXX SETS

FINISHES

HIGH GLOSS COVERING

- #21 SMOKEY CHROME
- #31 JET BLACK
- #33 PURE WHITE
- #91 RED WINE
- #702 ELECTRIC BLUE SPARKLE
- NEW** #708 GRINDSTONE SPARKLE

ALL DRUMS FEATURE CHROME HARDWARE



EPEXX 725/C

5 PC. SET w/ePRO CONVERSION KIT, 830 HARDWARE & PLASTIC CYMBALS **\$4,608**

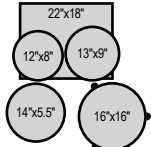

THRONE NOT INCLUDED

DRUMS:

- EXX 2218B/C 22"x18" BASS
- EXX 1208T/C 12"x8" TOM
- EXX 1309T/C 13"x9" TOM
- EXX 1616F/C 16"x16" FLOOR TOM
- EXX 1455S/C 14"x5.5" SNARE

830 HARDWARE:

- BC-830 BOOM STAND
- C-830 CYMBAL STAND
- H-830 HI-HAT STAND
- S-830 SNARE STAND
- P-930 PEDAL
- TH-701 TOM ARMS x 2
- UX-80 UNIVERSAL CLAMP x 1
- AX-25L ADAPTER W/REVOLVING CLAMPS

TRU-TRAC ELECTRONIC DRUMHEADS:

- TTP-B BASS
- TTP-12 TOM
- TTP-13 TOM
- TTP-16 FLOOR TOM
- TTP-14 SNARE

ELECTRONICS:

- RBM-20MUL R.E.D. BOX DRUM MODULE
- RDMM R.E.D. BOX MOUNTING BRACKET
- EPS-1UL R.E.D. BOX POWER SUPPLY
- EHH-2 TRU-TRAC HI-HAT CYMBALS
- EP-02P TRU-TRAC PLASTIC CYMBAL SET
- CH-10 CABLE BUNDLE
- NDA-1 JUNCTION BOX X 5

EPEXX 725S/C

5 PC. SET w/ePRO CONVERSION KIT, 830 HARDWARE & PLASTIC CYMBALS **\$4,608**

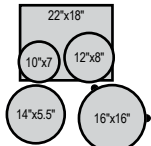

THRONE NOT INCLUDED

DRUMS:

- EXX 2218B/C 22"x18" BASS
- EXX 1007T/C 10"x7" TOM
- EXX 1208T/C 12"x8" TOM
- EXX 1616F/C 16"x16" FLOOR TOM
- EXX 1455S/C 14"x5.5" SNARE

830 HARDWARE:

- BC-830 BOOM STAND
- C-830 CYMBAL STAND
- H-830 HI-HAT STAND
- S-830 SNARE STAND
- P-930 PEDAL
- TH-701 TOM ARMS x 2
- UX-80 UNIVERSAL CLAMP x 1
- AX-25L ADAPTER W/REVOLVING CLAMPS

TRU-TRAC ELECTRONIC DRUMHEADS:

- TTP-B BASS
- TTP-10 TOM
- TTP-12 TOM
- TTP-16 FLOOR TOM
- TTP-14 SNARE

ELECTRONICS:

- RBM-20MUL R.E.D. BOX DRUM MODULE
- RDMM R.E.D. BOX MOUNTING BRACKET
- EPS-1UL R.E.D. BOX POWER SUPPLY
- EHH-2 TRU-TRAC HI-HAT CYMBALS
- EP-02P TRU-TRAC PLASTIC CYMBAL SET
- CH-10 CABLE BUNDLE
- NDA-1 JUNCTION BOX X 5

EPEXL SETS

FINISHES

HIGH GLOSS LACQUER

- #246 NATURAL CHERRY
- #248 BLACK SMOKE
- #249 HONEY AMBER
- NEW** #255 NIGHTSHADE LACQUER

ALL DRUMS FEATURE CHROME HARDWARE



EPEXL 725/C

5 PC. SET w/ePRO CONVERSION KIT, 830 HARDWARE & PLASTIC CYMBALS **\$4,758**

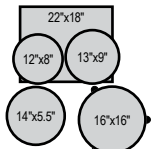

THRONE NOT INCLUDED

DRUMS:

- EXL 2218B/C 22"x18" BASS
- EXL 1208T/C 12"x8" TOM
- EXL 1309T/C 13"x9" TOM
- EXL 1616F/C 16"x16" FLOOR TOM
- EXL 1455S/C 14"x5.5" SNARE

830 HARDWARE:

- BC-830 BOOM STAND
- C-830 CYMBAL STAND
- H-830 HI-HAT STAND
- S-830 SNARE STAND
- P-930 PEDAL
- TH-701 TOM ARMS x 2
- UX-80 UNIVERSAL CLAMP x 1
- AX-25L ADAPTER W/REVOLVING CLAMPS

TRU-TRAC ELECTRONIC DRUMHEADS:

- TTP-B BASS
- TTP-12 TOM
- TTP-13 TOM
- TTP-16 FLOOR TOM
- TTP-14 SNARE

ELECTRONICS:

- RBM-20MUL R.E.D. BOX DRUM MODULE
- RDMM R.E.D. BOX MOUNTING BRACKET
- EPS-1UL R.E.D. BOX POWER SUPPLY
- EHH-2 TRU-TRAC HI-HAT CYMBALS
- EP-02P TRU-TRAC PLASTIC CYMBAL SET
- CH-10 CABLE BUNDLE
- NDA-1 JUNCTION BOX X 5

EPEXL 725S/C

5 PC. SET w/ePRO CONVERSION KIT, 830 HARDWARE & PLASTIC CYMBALS **\$4,758**

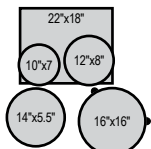

THRONE NOT INCLUDED

DRUMS:

- EXL 2218B/C 22"x18" BASS
- EXL 1007T/C 10"x7" TOM
- EXL 1208T/C 12"x8" TOM
- EXL 1616F/C 16"x16" FLOOR TOM
- EXL 1455S/C 14"x5.5" SNARE

830 HARDWARE:

- BC-830 BOOM STAND
- C-830 CYMBAL STAND
- H-830 HI-HAT STAND
- S-830 SNARE STAND
- P-930 PEDAL
- TH-701 TOM ARMS x 2
- UX-80 UNIVERSAL CLAMP x 1
- AX-25L ADAPTER W/REVOLVING CLAMPS

TRU-TRAC ELECTRONIC DRUMHEADS:

- TTP-B BASS
- TTP-10 TOM
- TTP-12 TOM
- TTP-16 FLOOR TOM
- TTP-14 SNARE

ELECTRONICS:

- RBM-20MUL R.E.D. BOX DRUM MODULE
- RDMM R.E.D. BOX MOUNTING BRACKET
- EPS-1UL R.E.D. BOX POWER SUPPLY
- EHH-2 TRU-TRAC HI-HAT CYMBALS
- EP-02P TRU-TRAC PLASTIC CYMBAL SET
- CH-10 CABLE BUNDLE
- NDA-1 JUNCTION BOX X 5

EPRO COCKTAIL KIT, TRU-TRAC CONVERSION KITS AND ACCESSORIES

NEW EPRO COCKTAIL KIT



EPCTK1424/SC \$3,299

- THE FIRST MULTI-ZONE ELECTRONIC COCKTAIL KIT
- INCLUDES 7 PROGRAMMABLE TRIGGERS w/ACCESS TO 1000 SOUNDS
- DUAL LAYERING CAPABILITY
- COMPLETE WITH ELIMINATOR CHAIN PEDAL
- CUSTOM WRAPPED DELMAR FINISHES

INCLUDES

- RBM20MUL R.E.D. BOX MODULE
- RDMM R.E.D. BOX MOUNTING BRK.
- DB25 AUDIO HARNESS x 2
- EPC14T 14" PLASTIC 3-ZONE RIDE CYMBAL
- TTPBD TRU-TRAC BASS DRUM PAD
- TTP10 10" TRU-TRAC PAD
- TTP14 14" TRU-TRAC PAD
- UX80 UNIVERSAL CLAMP x 2
- UX80L UNIVERSAL CLAMP
- TH930S TOM HOLDER
- P2002C ELIMINATOR CHAIN PEDAL
- PS85 PEDAL STABILIZER
- BC-830 BOOM CYMBAL STAND

TRU-TRAC PACK FULL CONVERSION KITS



WITH PLASTIC CYMBALS

EPADRBMP \$3,509

12"/13"/14"/16"/BASS TRU-TRAC HEADS

EPADRBMSM \$3,509

10"/12"/14"/16"/BASS TRU-TRAC HEADS

EACH KIT INCLUDES

- RBM20MUL R.E.D. BOX MODULE
- RDMM R.E.D. BOX MOUNTING BRK.
- CH10 CABLE BUNDLE
- AX25L MULTI-CLAMP
- EP02P TRU-TRAC PLASTIC CYMBAL SET
- EHH2 TRU-TRAC PLASTIC HI-HAT CYMBALS (PR)
- NDA-1 NO DRILL ADAPTER x 5
- 52MM TENSION RODS x 30
- 63MM TENSION RODS x 30
- NP485 VELCRO TAPE x 10
- BDMTP HOLE POSITION TEMPLATE
- BDPPT PAPER RULER
- HPC6 HOLE PUNCH
- BDC FOAM BASS DRUM CUSHION

TRU-TRAC ELECTRONIC DRUMHEAD CONVERSION KITS



TRU-TRAC ELECTRONIC DRUMHEADS

EPAD-25 \$1,749

12"/13"/14"/16"/BASS TRU-TRAC HEADS

EPADRBMSM \$1,749

10"/12"/14"/16"/BASS TRU-TRAC HEADS

EACH KIT INCLUDES

- CABLES
- NO DRILL ADAPTERS
- TENSION RODS
- TEMPLATES
- TRU-TRAC PADS

TRU-TRAC HI-HAT



EHH-2 \$199

TRU-TRAC HI-HATS MOUNT TO VIRTUALLY ANY HI-HAT STAND FOR A NATURAL PLAYING EXPERIENCE. WHEN COMBINED WITH THE R.E.D. BOX MODULE, IT PRODUCES SOUNDS FROM OPEN TO CLOSED, HALF OPEN AND THREE QUARTER POSITIONS PLUS CHICK AND SPLASH. IT'S THE PERFECT UPGRADE TO E-PRO LIVE AND TRU-TRAC PAD CONVERSION KITS.
SOFTWARE UPDATE REQUIRED - AVAILABLE FREE AT REDBOXSOUNDSHOP.COM

INCLUDES

- TOP AND BOTTOM CYMBALS
- FSR SENSING UNIT
- SPRING
- SOFTWARE UPDATE

TRU-TRAC COMPONENTS

TTP-B	BASS TRU-TRAC ELECTRONIC DRUMHEAD - FOR ALL BASS DRUM SIZES	\$249.00
TTP-10	10" TRU-TRAC ELECTRONIC DRUMHEAD - DUAL ZONE	319.00
TTP-12	12" TRU-TRAC ELECTRONIC DRUMHEAD - DUAL ZONE	369.00
TTP-13	13" TRU-TRAC ELECTRONIC DRUMHEAD - DUAL ZONE	379.00
TTP-14	14" TRU-TRAC ELECTRONIC DRUMHEAD - DUAL ZONE	399.00
TTP-16	16" TRU-TRAC ELECTRONIC DRUMHEAD - DUAL ZONE	479.00
EP02P	PLASTIC CYMBAL SET: EPC-14T 14" RIDE, EPC-12D 12" CRASH	279.00
RBM-20MUL	R.E.D. BOX MODULE	999.00

ELECTRONIC ACCESSORIES

THMP-1	THRONE THUMPER - FEEL THE BEAT THROUGH YOUR THRONE, 200 WATT BASH AMPLIFIER INCLUDED	\$499.00
PDM-250	PRECISION DRUM MONITORS - REFERENCE HEADPHONES	299.00
DR-2000	DRUMOMETER MODEL II - DEVELOPS SPEED, ACCURACY AND TECHNIQUE	199.99
TB-001	TUNE-BOT - FAST, ACCURATE AND EFFECTIVE ACOUSTIC DRUM TUNER	149.95
RDMM	R.E.D. BOX MODULE MOUNT - WITH 7/8" DIAMETER POST.....	10.00

SNARE DRUMS

TASK-SPECIFIC FREE FLOATING SNARE DRUMS

FTSS-1435	14"x3.5"	STAINLESS STEEL - 1MM, DIE CAST HOOPS, SS TENSION RODS, SR-160F STRAINER, BRUSHED FINISH	\$765.00
FTBR-1450	14"x5"	BRASS - 1MM, DIE CAST HOOPS, SS TENSION RODS, SR-160F STRAINER, BRUSHED FINISH	899.00
FTPB-1465	14"x6.5"	PHOSPHOR BRONZE - 1.2MM, DIE CAST HOOPS, SS TENSION RODS, SR-160F STRAINER, BRUSHED FINISH	1,100.00
FTAL-1480	14"x8"	SEAMLESS ALUMINUM - 1.2MM, DIE CAST HOOPS, SS TENSION RODS, SR-160F STRAINER, BRUSHED FINISH	1,030.00
FTBB-1435	14"x3.5"	BIRCH - 6 PLY 5.4MM, DIE CAST HOOPS, SS TENSION RODS, SR-160F STRAINER, #320 SATIN BIRCH	730.00
FTMM-1450	14"x5"	MAPLE - 6 PLY 7.5MM, DIE CAST HOOPS, SS TENSION RODS, SR-160F STRAINER, #321 SATIN MAPLE	799.00
FTMMH-1465	14"x6.5"	MAPLE/AFRICAN MAHOGANY - 6 PLY 7.5MM, DIE CAST HOOPS, SS TENSION RODS, SR-160F, #322 SATIN MAHOGANY ON MAPLE	830.00
FTMH-1480	14"x8"	AFRICAN MAHOGANY - 8 PLY 10MM, DIE CAST HOOPS, SS TENSION RODS, SR-160F, #324 SATIN RED MAHOGANY	1,030.00

*ACRYLIC FREE FLOATING REPLACEMENT SHELLS FOR ALL SIZES - SEE PAGE 11

SENSITONE SNARE DRUMS

STA-1450S	14"x5"	BEADED STEEL - 1MM, SUPERHOOP II, TB-55 LUGS, SR-150, SN-1420I, CHROME PLATED	\$499.00
STA-1465S	14"x6.5"	BEADED STEEL - 1MM, SUPERHOOP II, TB-65 LUGS, SR-150, SN-1420I, CHROME PLATED	515.00
STA-1450BR	14"x5"	BEADED BRASS - 1MM, SUPERHOOP II, TB-55 LUGS, SR-150, SN-1420I, BLACK NICKEL PLATED	749.00
STA-1465BR	14"x6.5"	BEADED BRASS - 1MM, SUPERHOOP II, TB-65 LUGS, SR-150, SN-1420I, BLACK NICKEL PLATED	780.00
STA-1450AL	14"x5"	BEADED SEAMLESS ALUMINUM - 1.2MM, SH II, TB-55 LUGS, SR-150, SN-1420I, CLEAR LACQUER FINISH	599.00
STA-1465AL	14"x6.5"	BEADED SEAMLESS ALUMINUM - 1.2MM, SH II, TB-65 LUGS, SR-150, SN-1420I, CLEAR LACQUER FINISH	615.00
STA-1450FB	14"x5"	PREMIUM BEADED BRASS - 1.5MM, SUPERHOOP II, ARL-55 LUGS, SR-150, SN-1420I, PATINA FINISH	965.00
STA-1465FB	14"x6.5"	PREMIUM BEADED BRASS - 1.5MM, SUPERHOOP II, ARL-65 LUGS, SR-150, SN-1420I, PATINA FINISH	1,049.00
STA-1450PB	14"x5"	PREMIUM BEADED PHOSPHOR BRONZE - 1.2MM, SUPERHOOP II, ARL-55 LUGS, SR-150, SN-1420I, CLEAR LACQUER FINISH	980.00
STA-1465PB	14"x6.5"	PREMIUM BEADED PHOSPHOR BRONZE - 1.2MM, SUPERHOOP II, ARL-65 LUGS, SR-150, SN-1420I, CLEAR LACQUER FINISH	1,049.00
STA-1450MM	14"x5"	PREMIUM MAPLE - 6 PLY 5.4MM, SUPERHOOP II, ARL-55 LUGS, SR-150, SN-1420I, #321 SATIN MAPLE	649.00
STA-1465MM	14"x6.5"	PREMIUM MAPLE - 6 PLY 5.4MM, SUPERHOOP II, ARL-65 LUGS, SR-150, SN-1420I, #321 SATIN MAPLE	699.00
STA-1550MH	15"x5"	PREMIUM AFRICAN MAHOGANY - 4 PLY 5MM w/MAPLE RINGS, SH II, ARL-55, SR-150, SN-1420I, #325 SATIN MAHOGANY	715.00

HYBRID EXOTIC SNARE DRUMS w/SPIN-TIGHT TENSION RODS (TOP)

HEP-1450	14"x5"	VECTORCAST - SUPERHOOP II, STL-100 LUGS, SR-1000, SN-1420I	\$1,215.00
HEP-1465	14"x6.5"	VECTORCAST - SUPERHOOP II, STL-100 LUGS, SR-1000, SN-1420I	1,299.00
HEAL-1450	14"x5"	CAST ALUMINUM - 3MM, SUPERHOOP II, STL-100 LUGS, SR-1000, SN-1420I, BLACK LACQUER FINISH	1,315.00
HEAL-1465	14"x6.5"	CAST ALUMINUM - 3MM, SUPER HOOP II, STL-100 LUGS, SR-1000, SN-1420I, BLACK LACQUER FINISH	1,330.00
HEK-1450	14"x5"	KAPUR/FIBERGLASS - 6 PLY 7.5MM, SUPERHOOP II, STL-100 LUGS, SR-1000, SN-1420I, #308 EBONY LACQUER w/PEARL INLAY	980.00
HEK-1465	14"x6.5"	KAPUR/FIBERGLASS - 6 PLY 7.5MM, SUPERHOOP II, STL-100 LUGS, SR-1000, SN-1420I, #308 EBONY LACQUER w/PEARL INLAY	999.00
HEK-1480	14"x8"	KAPUR/FIBERGLASS - 6 PLY 7.5MM, SUPERHOOP II, STL-100 LUGS, SR-1000, SN-1420I, #308 EBONY LACQUER w/PEARL INLAY	1,030.00

SIGNATURE SERIES SNARE DRUMS

NEW CS-1465F	14"x6.5"	CHAD SMITH - 3MM BRASS/STEEL/BRASS STACKABLE SHELLS, DIE CAST HOOPS, SR-1000F, SS TENSION RODS, CLEAR LACQUER	\$1,599.00
CS-1450	14"x5"	CHAD SMITH - STEEL, SUPERHOOP II, SR-015, STAINLESS STEEL TENSION RODS, BLACK NICKEL	499.00
OH-1350	13"x5"	OMAR HAKIM - AFRICAN MAHOGANY 6 PLY 7.5MM, SUPERHOOP II, SR-015, SS TENSION RODS, #140 NATURAL MAHOGANY	730.00
IP-1465	14"x6.5"	IAN PAICE - STEEL, TUBE LUGS, SUPERHOOP II, SR-017, STAINLESS STEEL TENSION RODS, CHROME	660.00
DC-1465	14"x6.5"	DENNIS CHAMBERS - MAPLE 4 PLY 5MM, DIE CAST HOOPS, SR-020 x 2, 20 LUGS, SS TENSION RODS, #136 OPAL WHITE	1,050.00
JJ-1365	13"x6.5"	JOEY JORDISON - STEEL, SR-017, CL-65 LUGS, BLACK LACQUER/BLACK HARDWARE/SLIPKNOT GRAPHICS (WHILE SUPPLIES LAST)	549.00

REFERENCE SERIES SNARE DRUMS *C=CHROME /B=BLACK CHROME PLATED /G=GOLD PLATED DRUM HARDWARE

RF-1365S	13"x6.5"	25MM 20PLY (14 MAPLE + 6 BIRCH) - BRL-65 LUGS, DIE CAST HOOPS, SR-1000 w/SN-1420D SNARES - HW COLOR: C/B/G*	\$1,250.00
RF-1450S	14"x5"	25MM 20PLY (14 MAPLE + 6 BIRCH) - BRL-55 LUGS, DIE CAST HOOPS, SR-1000 w/SN-1420D SNARES - HW COLOR: C/B/G*	1,200.00
RF-1465S	14"x6.5"	25MM 20PLY (14 MAPLE + 6 BIRCH) - BRL-65 LUGS, DIE CAST HOOPS, SR-1000 w/SN-1420D SNARES - HW COLOR: C/B/G*	1,300.00
RFP-1365S	13"x6.5"	5.4MM 6PLY (4 MAPLE + 2 BIRCH) - STL-65 LUGS, FAT TONE HOOPS, SR-1000 w/SN-1420D SNARES - CHROME HW ONLY	980.00
RFP-1450S	14"x5"	5.4MM 6PLY (4 MAPLE + 2 BIRCH) - STL-55 LUGS, FAT TONE HOOPS, SR-1000 w/SN-1420D SNARES - CHROME HW ONLY	1,050.00
RFP-1465S	14"x6.5"	5.4MM 6PLY (4 MAPLE + 2 BIRCH) - STL-65 LUGS, FAT TONE HOOPS, SR-1000 w/SN-1420D SNARES - CHROME HW ONLY	1,100.00
RFS-1450	14"x5"	CAST STEEL - 3MM, BRL-55 LUGS, DIE CAST HOOPS, SR-1000 w/SN-1420D SNARES - CHROME HW ONLY	1,300.00
RFS-1465	14"x6.5"	CAST STEEL - 3MM, BRL-65 LUGS, DIE CAST HOOPS, SR-1000 w/SN-1420D SNARES - CHROME HW ONLY	1,365.00
RFB-1450	14"x5"	BRASS SHELL - 3MM, BRL-55 LUGS, DIE CAST HOOPS, SR-1000 w/SN-1420D SNARES - CHROME HW ONLY	1,650.00
RFB-1465	14"x6.5"	BRASS SHELL - 3MM, BRL-65 LUGS, DIE CAST HOOPS, SR-1000 w/SN-1420D SNARES - CHROME HW ONLY	1,830.00

MASTERS SNARE DRUMS

MCX-1455S/C	14"x5.5"	6 PLY 7.5MM MAPLE - DIE CAST HOOPS, CL-55 BRIDGE LUGS, STEEL TENSION RODS, SR-017 STRAINER, S-022N SNARES	\$640.00
MCX-1465S/C	14"x6.5"	6 PLY 7.5MM MAPLE - DIE CAST HOOPS, CL-65 BRIDGE LUGS, STEEL TENSION RODS, SR-017 STRAINER, S-022N SNARES	680.00
BCX-1455S/C	14"x5.5"	6 PLY 7.5MM BIRCH - DIE CAST HOOPS, CL-55 BRIDGE LUGS, STEEL TENSION RODS, SR-017 STRAINER, S-022N SNARES	500.00
BCX-1465S/C	14"x6.5"	6 PLY 7.5MM BIRCH - DIE CAST HOOPS, CL-65 BRIDGE LUGS, STEEL TENSION RODS, SR-017 STRAINER, S-022N SNARES	530.00

SESSION SNARE DRUMS

SSC-1455S/C	14"x5.5"	6 PLY BIRCH/KAPUR - SH II, CL-55 BRIDGE LUGS, SS TENSION RODS, SR-017 STRAINER, S-022N SNARES	\$350.00
SSC-1465S/C	14"x6.5"	6 PLY BIRCH/KAPUR - SH II, CL-65 BRIDGE LUGS, SS TENSION RODS, SR-017 STRAINER, S-022N SNARES	380.00

PICCOLO / POPCORN / EFFECTS SNARE DRUMS

M-1060	10"x6"	6 PLY MAPLE POPCORN SNARE CL-65 LUGS, 1.6MM HOOPS, SR-018 STRAINER, S-032 SNARES, #102 NATURAL MAPLE	\$520.00
M-1270	12"x7"	8 PLY MAPLE CL-100 LUGS, 1.6MM HOOPS, SR-018 STRAINER, S-031N SNARES, #114 LIQUID AMBER	680.00
M-1330	13"x3"	6 PLY MAPLE PICCOLO CL-05 LUGS, 1.6MM HOOPS, SR-018, #102 NATURAL MAPLE & #114 LIQUID AMBER	450.00
B-1330	13"x3"	BRASS PICCOLO CL-05 LUGS, 1.6MM HOOPS, STEEL TENSION RODS, SR-018 STRAINER, S-029N SNARES	370.00
S-1330B	13"x3"	STEEL PICCOLO CL-05 LUGS, 1.6MM HOOPS, SR-018 STRAINER, S-029N SNARES, BLACK LACQUER	280.00

FIRECRACKER SNARE DRUMS

FCS-1050	10"x5"	STEEL - CL-50 LUGS, 1.6MM HOOPS, STEEL TENSION RODS, SR-018 STRAINER, S-032 SNARES	\$230.00
FCP-1250	12"x5"	8 PLY POPLAR - CL-50 LUGS, 1.6MM HOOPS, STEEL TENSION RODS, SR-018, S-031 SNARES, #271 EBONY MIST	260.00

PEARL HARDWARE

SINGLE PEDALS

P-3000D w/CASE	DEMON DIRECT DRIVE w/DUO-DECK CONVERTIBLE SHORT/LONG FOOTBOARD, INDEPENDENT BEATER & FOOTBOARD ANGLE ADJUSTMENTS, NINJA BEARINGS	\$529.00
P-3000C w/CASE	DEMON CHAIN DRIVE w/DUO-DECK CONVERTIBLE SHORT/LONG FOOTBOARD, INDEPENDENT BEATER & FOOTBOARD ANGLE ADJUSTMENTS, NINJA BEARINGS	529.00
P-2000C w/CASE	POWERSHIFTER ELIMINATOR w/DUAL CHAIN DRIVE INTERCHANGEABLE CAM DRIVE SYSTEM, POWERSHIFTER, QUAD-BEATER, TRACTION-CONTROL FOOTBOARD	309.00
P-2000B w/CASE	POWERSHIFTER ELIMINATOR w/BELT DRIVE INTERCHANGEABLE CAM DRIVE SYSTEM, POWERSHIFTER, QUAD-BEATER, TRACTION-CONTROL FOOTBOARD	309.00
P-930	LONGBOARD INTERCHANGEABLE CAM, POWERSHIFTER	149.00
P-830	LONGBOARD w/RADIUS ROD	129.00

DOUBLE PEDALS - COMPLETE

P-3002D w/CASE	DEMON DIRECT DRIVE w/DUO-DECK CONVERTIBLE SHORT/LONG FOOTBOARD, Z-LINK ZERO-LATENCY DRIVE SHAFT, INDEPENDENT BEATER & FOOT BOARD ANGLE ADJUSTMENTS, NINJA BEARINGS	\$1,279.00
P-3002C w/CASE	DEMON CHAIN DRIVE w/DUO-DECK CONVERTIBLE SHORT/LONG FOOTBOARD, Z-LINK ZERO-LATENCY DRIVE SHAFT, INDEPENDENT BEATER & FOOT BOARD ANGLE ADJUSTMENTS, NINJA BEARINGS	1,279.00
P-3002DL	DEMON DIRECT DRIVE L-FOOTED w/CASE	1,279.00
P-3002CL	DEMON CHAIN DRIVE L-FOOTED w/CASE	1,279.00
P-2002C	ELIMINATOR RIGHT-FOOTED w/CASE - CHAIN DRIVE	679.00
P-2002CL	ELIMINATOR LEFT-FOOTED w/CASE - CHAIN DRIVE	679.00
P-2002B	ELIMINATOR RIGHT-FOOTED w/CASE - BELT DRIVE	679.00
P-2002BL	ELIMINATOR LEFT-FOOTED w/CASE - BELT DRIVE	679.00
P-932	LONGBOARD RIGHT-FOOTED - SINGLE CHAIN	399.00
P-932L	LONGBOARD LEFT-FOOTED - SINGLE CHAIN	399.00

DOUBLE PEDAL CONVERSION KITS

P-3001D	DEMON DIRECT DRIVE R-FOOTED w/CASE	\$899.00
P-3001C	DEMON CHAIN DRIVE R-FOOTED w/CASE	899.00
P-2001C	ELIMINATOR R-FOOTED w/CASE - CHAIN DRIVE	499.00
P-2001B	ELIMINATOR R-FOOTED w/CASE - BELT DRIVE	499.00
P-931	LONGBOARD R-FOOTED - SINGLE CHAIN	319.00

BOOM CYMBAL STANDS

BC-2030	GYRO-LOCK TILTER, TRIDENT TRIPOD, REVERSIBLE FOAM/FELT WASHERS, PUSH BUTTON SPIKE/RUBBER FEET "READY" w/TELESCOPIC BOOM ARM, WINGLOC, DETACHABLE TILTER & COUNTERWEIGHT 1 1/8", 7/8", 5/8", 5/8" + 12MM ROD	\$379.00
BC-1030	GYRO-LOCK TILTER, TRIDENT TRIPOD, REVERSIBLE FOAM/FELT WASHERS, PUSH BUTTON SPIKE/RUBBER FEET "READY" w/WINGLOC 1 1/8", 7/8", 5/8" + 12MM ROD	239.00
BC-930	UNI-LOCK TILTER, TRIDENT DESIGN TRIPOD 1 1/8", 7/8", 5/8" + 12MM ROD	159.00
BC-830	UNI-LOCK TILTER DBL BR TRIPOD 1", 7/8", 5/8" + 12MM ROD	119.00

CYMBAL STANDS

C-1030	GYRO-LOCK TILTER, TRIDENT TRIPOD, REVERSIBLE FOAM/FELT WASHERS, PUSH BUTTON SPIKE/RUBBER FEET "READY" w/WINGLOC - 1 1/8", 7/8", 5/8"	\$229.00
C-930	UNI-LOCK TILTER, TRIDENT DESIGN TRIPOD - 1 1/8", 7/8", 5/8"	139.00
C-830	UNI-LOCK TILTER DBL BR LEGS - 1", 7/8", 5/8"	99.00

SNARE STANDS

S-1030	GYRO-LOCK TILTER, TRIDENT TRIPOD, PUSH BUTTON SPIKE/RUBBER FEET "READY," ALL-FIT BASKET (10"-16") AIR SUSPENSION TIPS 1 1/8", 7/8" - (18.5" ~ 25.98")	\$249.00
S-930	UNI-LOCK TILTER, TRIDENT DESIGN TRIPOD, AIR SUSPENSION TIPS, FITS 10"~ 14" DRUMS 1 1/8", 7/8" - (18.11" ~ 25.59")	119.00
S-930D	S-930 LOW VERSION - 1 1/8", 7/8" - (14.57" ~ 21.65")	139.00
S-830	UNI-LOCK TILTER - 1", 7/8" - (16.93" ~ 24.41")	99.00

HI-HAT STANDS

H-2000	ELIMINATOR w/INTERCHANGEABLE CAM SYSTEM SUPERGRIP CLUTCH w/LOCK NUT, PUSH BUTTON SPIKE/RUBBER TIPS, SWIVEL LEGS - 1 1/8", 1"	\$509.00
RH-2000	ELIMINATOR REMOTE-HAT w/8 FOOT CABLE, DROP CLUTCH, FOOTBOARD DOCKING STATION	509.00
H-1000	DIRECT DRIVE w/SPIKE/RUBBER TIPS, ADJUSTABLE FOOTBOARD ANGLE, SWIVEL LEGS - 1 1/8", 1"	375.00
H-930	LONGBOARD - SWIVEL LEGS, ADJ SPRING - 1 1/8", 7/8"	219.00
H-830	LONGBOARD - SWIVEL LEGS - 1", 7/8"	140.00

ROADSTER THRONES

D-2500BR	BACKREST THRONE w/MOTORCYCLE-TYPE SEAT, LOCKING SEAT BRACKET, QUICK-RELEASE BACKREST w/ADJUSTABLE LUMBAR SUPPORT, TRIDENT DESIGN TRIPOD - 1 1/8", 7/8" - (19.49" ~ 26.18")	\$499.00
D-2500	MOTORCYCLE-TYPE SEAT - BACKREST READY, LOCKING SEAT BRACKET, TRIDENT DESIGN TRIPOD 1 1/8", 7/8" - (19.49" ~ 26.18")	379.00
D-1000N	ROUND SEAT w/HI-DENSITY FOAM, LOCKING SEAT BRACKET, NEW TRIDENT DESIGN TRIPOD 1 1/8", 7/8" - (19.49" ~ 26.18")	299.00
D-1000SN	SHORT D-1000N - 1 1/8", 7/8" - (17.91" ~ 24.61")	299.00
D-1000SPN	SHOCK ABSORBER POST w/ROUND SEAT, LOCKING SEAT BRACKET, TRIDENT DESIGN TRIPOD 1 1/8", 1" - (20.67" ~ 24.8")	299.00

THRONES

D-930	ROUND SEAT - TRIDENT DESIGN TRIPOD, POST w/STOP LOCK - 1 1/8", 7/8" - (18.5" ~ 25.98")	\$169.00
D-790	ROUND SEAT - DOUBLE BRACED TRIPOD, POST w/STOP LOCK 1 1/8", 7/8" - (18.11" ~ 25.98")	119.00
D-730S	ROUND SEAT - SINGLE BRACED TRIPOD, POST w/STOP LOCK 1 1/8", 7/8" - (15.94" ~ 22.83")	109.00

TOM STANDS

T-1030	TRIDENT TRIPOD PUSH BUTTON SPIKE/RUBBER FEET "READY" w/(2) NEW GYRO-LOCK TH-1030S & ADP-30	\$389.00
T-930	TRIDENT DESIGN TRIPOD w/(2) TH-900S & ADP-30	279.00
T-890	FOR ROCKET & CONCERT TOMS	239.00

TOM / CYMBAL STANDS

TC-1030	TRIDENT TRIPOD, PUSH BUTTON SPIKE/RUBBER FEET "READY" w/GYRO-LOCK TH-1030S & CH-1030	\$439.00
TC-930	TRIDENT DESIGN TRIPOD w/TH-900S & CH-930	309.00

MULTI-FIT BASS DRUM LEGS

PMBDL3/C	SUSPENDS CONCERT-MARCHING-DRUMSET BASS DRUMS HORIZONTALLY NO DRILLING! HEIGHT & TILT ADJ - SET OF 3 - CHROME PLATED ..	\$332.00
-----------------	---	-----------------

RACKS

DR-503	ICON 3-SIDED RACK w/36" STRAIGHT BARS HEIGHT ADJUSTABLE, (4) PCX-100, (2) PCL-100	\$769.00
DR-503C	ICON 3-SIDED RACK w/44" CURVED BARS HEIGHT ADJUSTABLE, (4) PCX-100, (2) PCL-100	769.00
DR-501	ICON FRONT RACK w/36" STRAIGHT BAR HEIGHT ADJUSTABLE, (2) PCX-100, (2) PCL-100	359.00
DR-501C	ICON FRONT RACK w/44" CURVED BAR HEIGHT ADJUSTABLE, (2) PCX-100, (2) PCL-100	379.00
DR-501E	ICON STRAIGHT 36" EXPANSION BAR	199.00
DR-501CE	ICON CURVED 44" EXPANSION BAR	229.00
DR-100L	ICON SHORT LEG - LEFT - USED TO CONVERT DR-503C RACKS FOR DOUBLE BASS - REQUIRES 1 x DR-100R & 2 x RJ-100	159.00
DR-100R	ICON SHORT LEG - RIGHT - USED TO CONVERT DR-503C RACKS FOR DOUBLE BASS - REQUIRES 1 x DR-100L & 2 x RJ-100	159.00
DR-80	3-SIDED RACK w/35.9" STRAIGHT BARS, (4) PC-8	349.00
DR-008	DR-80 EXPANSION BAR	119.00

RACK ACCESSORIES

RJ-50	ICON 6" MINI-EXPANSION BAR	\$99.00
RJ-100	PIPE JOINT USED WITH DR-100L / DR-100R	60.00
PCX-100	PIPE CLAMP w/ADJUSTABLE JAW FOR ICON/DR110/DR210	49.00
PCX-200	PIPE CLAMP w/TILTING CLAMP & ADJUSTABLE JAW	55.00
PC-8	PIPE CLAMP FOR DR-80 - FITS 7/8" TUBES	39.00
PCL-100	PIPE CLAMP FITS 1.5" LEG TUBES FOR 7/8" TUBES	29.00

930 SERIES HARDWARE PACK w/UNI-LOCK TILTERS

HWP-930	BC-930, C-930, H-930, S-930, P-930	\$770.00
----------------	---	-----------------

830 SERIES HARDWARE PACK w/UNI-LOCK TILTERS

HWP-830	BC-830, C-830, H-830, S-830, P-930	\$599.00
----------------	---	-----------------

ADAPTERS & ACCESSORIES

BOOM CYMBAL HOLDERS

CH-1030	GYRO-LOCK TILTER - WINGLOC, BUILT-IN COWBELL ROD, 7/8" DIA. POST w/STOP LOCK	\$149.00
CH-930	UNI-LOCK TILTER - 7/8" DIA POST w/STOP LOCK	99.00
CH-830	UNI-LOCK TILTER - 7/8" DIA POST w/STOP LOCK	69.00
CH-70	GEAR TILTER w/QUICK RELEASE BRKT	69.00

TOM HOLDERS

TH-1030	GYRO-LOCK TILTER (14"x4") w/7/8" DIA POST	\$139.00
TH-1030I	GYRO-LOCK TILTER (14"x3") w/7/8" DIA POST	139.00
TH-1030S	GYRO-LOCK TILTER (5"x4") w/7/8" DIA POST	139.00
TH-900I	UNI-LOCK (13"x3") FOR VISION w/7/8" DIA POST	79.00
TH-900S	UNI-LOCK (4"x4") FOR VISION w/7/8" DIA POST	79.00
TH-88I	GEAR (13"x3") w/7/8" DIA POST	59.00
TH-88S	GEAR (4"x4") w/7/8" DIA POST	59.00
TH-70I	GEAR (13"x3") w/7/8" DIA POST	49.00
TH-70S	GEAR (4"x4") w/7/8" DIA POST	49.00

OPTIMOUNT

OPTA-0665/C	6.5" DEPTH x 6"-16" DIA - ALUMINUM	\$133.00
OPTA-0708/C	7"-8" DEPTH x 6"-16" DIA - ALUMINUM	133.00
OPTA-0910/C	9"-10" DEPTH x 6"-16" DIA - ALUMINUM	133.00
OPTA-1112/C	11"-12" DEPTH x 6"-16" DIA - ALUMINUM	133.00
OPTA-1314/C	13"-14" DEPTH x 6"-16" DIA - ALUMINUM	133.00
OPTA-1516/C	15"-16" DEPTH x 6"-16" DIA - ALUMINUM	133.00
OPT-0708	7"-8" DEPTH x 6"-16" DIA - STEEL	72.00
OPT-0910	9"-10" DEPTH x 6"-16" DIA - STEEL	72.00
OPT-1112	11"-12" DEPTH x 6"-16" DIA - STEEL	72.00
OPT-1314	13"-14" DEPTH x 6"-16" DIA - STEEL	72.00
OPT-1516	15"-16" DEPTH x 6"-16" DIA - STEEL	72.00
OPL-0608/C	OPTI-LOC FOR EXX (ONLY) 6" & 8" DIA	49.00
OPL-1016/C	OPTI-LOC FOR EXX (ONLY) 10" ~ 16" DIA	49.00

I.S.S.

ISS-0810	FITS 8"-10" 1.6MM VISION w/BT-300	\$49.00
ISS-1216	FITS 12"-16" 1.6MM VISION w/BT-300	49.00
IS-0810SL/C	FITS 8"-10" 2MM STEEL/STAINLESS & SH II w/BT-3	49.00
IS-1216SL/C	FITS 12"-16" 2MM STEEL/STAINLESS & SH II w/BT-3	49.00

ADAPTERS

ADP-20	2 QUICK RELEASE CLAMPS FITS 5/8"-1 1/8"	\$49.00
ADP-30	3 QUICK RELEASE CLAMPS FITS 3/8"-1 1/4"	79.00
AX-25	2 QUICK RELEASE REVOLVING CLAMPS FITS 1/2"-1 1/8"	58.00
AX-25L	LONG VERSION OF THE AX-25	65.00
AX-28	FIXED QR CLAMP 5/8"-1 1/8" + REVOLVING QR CLAMP 1/2"-1 1/8"	58.00
UX-80	QR REVOLVING CLAMP FITS 1/2"-1 1/8" w/13" LONG 7/8" DIA TUBE ..	72.00
UX-80S	QR REVOLVING CLAMP FITS 1/2"-1 1/8" w/4" LONG 7/8" DIA TUBE ..	72.00

COWBELL HOLDERS

75H	HOOP MOUNTED w/NON-MARRING CLAMP SURFACES	\$39.00
75X	7/8" DIA POST w/GEAR TILTER	49.00
CA-130	NEW HOOP CLAMP SYSTEM - FULLY ADJUSTABLE	49.00
PPS-37	MULTI-ANGLE "L" ARM w/QUICK RELEASE BRACKET	49.00

BASS PEDAL ACCESSORIES

PS-85	PEDAL STABILIZER FOR DOUBLE PEDALS	\$49.00
JG-16	JUNGLE GIG - 16" FT TO BASS DRUM CONVERSION KIT (I.S.S. NOT INCLUDED)	59.00

HI-HAT ACCESSORIES

CLH-930	CLOSED HAT w/KNURLED BOOM ARM, UNI-LOCK	\$149.00
HA-130	HI-HAT TO BD ATTACHMENT w/NEW HOOP CLAMP	95.00

SNARE STAND ACCESSORIES

SBA-1/3	SNARE BASKET ADAPTER ACCEPTS 10" DRUMS	\$31.00
TX-100	HEIGHT EXTENDER FOR 7/8" DIA. TUBES - 13" TALL	69.00

ACCESSORY PACKS

UGK-1	UPGRADE KIT w/QUAD BEATER, R-40, NP-210/2, NP-208	\$62.00
-------	---	----------------

PRACTICE PADS

SD-50	8" PAD w/STAND - SOFT FEEL	\$149.00
BD-10	BASS PRACTICE PAD	149.00
RP-50	RUBBER DISK SET 12", 13", 14", 16", BD	259.00
RP-40C	RUBBER CYMBAL PADS 18/20 RIDE, 14/16 CRASH, 14 HATS	129.00
RPG-14	14" TWO-LEVEL RUBBER PRACTICE PAD	35.00
RT-08PL	8" REMO TUNEABLE PRACTICE PAD	51.00
PH-0108	REPLACEMENT DRUM HEAD FOR RT-08PL ONLY	14.00

DRUM PARTS

STRAINERS

SR-012	VERTICAL PULL - COMPLETE	\$46.00
SR-700/C	FORUM FZH - COMPLETE	58.00
SR-015	GLADSTONE TYPE - COMPLETE	58.00
SR-017	SENSITONE & MCX - COMPLETE	50.00
SR-018	PICCOLO (COMPLETE)	46.00
SR-020	MULTI-TRACE (COMPLETE)	69.00

SR-900	VISION VML-VBL-VBA-VB (COMPLETE)	\$84.00
SR-1000	GLIDE-LOCK (COMPLETE)	189.00
SR-1000F	GLIDE-LOCK FOR FREE FLOATER (COMPLETE)	189.00
SR-160F	FREE FLOATER 2014 w/CLICK-LOCK TECHNOLOGY (COMPLETE)	81.00
SR-150	SENSITONE 2014 w/CLICK-LOCK TECHNOLOGY (COMPLETE)	93.00

SNARES

SN-1320I	20 STRAND ULTRASOUND - "I" TYPE FOR 13" w/CORDS	\$23.00
SN-1320C	20 STRAND ULTRASOUND - "C" TYPE FOR 13" w/CORDS	23.00
SN-1320D	20 STRAND ULTRASOUND - "D" TYPE FOR 13" w/CORDS	23.00
SN-1420I	20 STRAND ULTRASOUND - "I" TYPE FOR 14" w/CORDS	21.00
SN-1420C	20 STRAND ULTRASOUND - "C" TYPE FOR 14" w/CORDS	21.00
SN-1420D	20 STRAND ULTRASOUND - "D" TYPE FOR 14" w/CORDS	21.00
SN-1442I	42 STRAND ULTRASOUND - "I" TYPE FOR 14" w/CORDS	53.00
SN-1442C	42 STRAND ULTRASOUND - "C" TYPE FOR 14" w/CORDS	53.00
SN-1442D	42 STRAND ULTRASOUND - "D" TYPE FOR 14" w/CORDS	53.00
S-022N	20 STRAND FOR 14" w/CORDS	17.00
S-022NU	20 STRAND FOR 14" w/CORDS - UNCOATED	17.00

S-022NG	20 STRAND FOR 14" w/CORDS - GOLD PLATED	\$47.00
S-022	20 STRAND w/STRAPS FOR 14"	15.00
S-029N	20 STRAND w/CORDS FOR 13"	17.00
S-030N	24 STRAND w/CORDS FOR 14"	21.00
S-031N	20 STRAND w/CORDS FOR 12"	17.00
S-032N	12 STRAND w/CORDS FOR 10"	16.00
S-033N	12 STRAND w/CORDS FOR 12"	16.00
S-040	15 STRAND STEEL CABLE w/CORDS FOR 14"	47.00
S-041	15 STRAND BRONZE CABLE w/CORDS FOR 14"	53.00
SPS-18/6	PLASTIC STRAPS (6/PKG)	4.00
SNC-40/6	SNARE CORD (6/PKG)	4.00

BASS DRUM PARTS

SP-300/2	SPURS FOR MW/RF/RF PURE (PAIR)	\$189.00
SP-30/2	SPURS FOR MCX (PAIR)	126.00
BSP-300C/2	SPURS FOR VML-VBL-VBA-VB (PAIR)	158.00
BSP-70C/2	SPURS FOR FORUM FZH (PAIR)	116.00
R-30A/2	RUBBER TIPS FOR SP-30 (PAIR)	12.00
CW-300	CLAW FOR MW/RF/RF PURE	15.00
D-054	CLAW FOR MCX/SSC	8.00

BDCWAV16	CHROME CLAW & T-ROD SET FOR ALL VISION (16)	\$99.00
BDCWAV16/B	BLACK CLAW & T-ROD SET FOR VBL-VB (16)	99.00
HPP-2	METAL HOOP PROTECTOR FOR WOOD HOOPS	5.00
NP-347/2	NON-SLIP HOOP PROTECTOR FOR WOOD HOOPS (2)	5.00
NP-01	HOOP PROTECTOR FOR METAL HOOPS	3.00
BB-3	BD BRACKET w/TWIN 7/8" RECEIVERS	57.00
BB-70/C	BD BRACKET w/TWIN 7/8" RECEIVERS FOR FZH - CHROME	40.00
BBC-1	MASKING PLATE FOR BB-3	18.00

RACK TOM & FLOOR TOM PARTS

BT-3	TT BRACKET 7/8" RECEIVER	\$34.00
GK-90	MASKING PLATE FOR BT-3 w/INSIDE/OUTSIDE PLATES & BOLTS ..	9.00
LB-200	LEG BRKT FOR MASTERWORKS/RF/RFP/MASTERS PREMIUM	28.00
LG-200/3	LEGS (3) FOR MW/RF/RFP/MP w/AIR SUSPENSION FEET - 3/8" DIA ..	81.00
LB-40	LEG BRKT FOR MCX/VMX	19.00
LG-40/3	LEGS (3) FOR MCX/VMX w/AIR SUSPENSION FEET - 3/8" DIA - 21" ..	55.00
LG-40L/3	LEGS (3) FOR MCX/VMX EXTRA LONG - 27"	67.00

FTB-200/C	LEG BRKT FOR VBL/VBA/VB	\$25.00
FTL-200C/3	LEGS FOR VBL/VBA/VB (3)	36.00
FTB-07/C	LEG BRKT FOR FORUM FZH	15.00
FTL-07C/3	LEGS FITS FTB-07 & LB-15 LEG BRKTS (3)	32.00
R-40/3	AIR SUSPENSION FEET FITS 3/8" DIA LEGS (3)	19.00
R-5/3	FEET FITS 3/8" DIA LEGS (3)	7.00

HARDWARE PARTS

THRONE PARTS

BR-2500A BACKREST & BRACKET FOR D-2500 THRONE \$157.00

PUSH BUTTON SPIKE/RUBBER FEET

CVT-300/3 FOR BC-2030, BC-1030, C-1030, S-1030, S-1030L,
T-1030, TC-1030 - SET OF THREE \$131.00

BOOM / CYMBAL STAND PARTS

TL-2030 GYROLOCK TILTER UNIT FOR BC-2030 & BC-2000 \$99.00
 WL-200 WINGLOC QUICK RELEASE WINGNUT 8MM THREAD 15.00
 M-8W/2 WING NUT FOR TILTER W/8MM THREAD (2) 6.00
 FL-90/2 CYMBAL FELT - LARGE (2) 6.00
 NP-69/2 PLASTIC SLEEVE FOR TILTER (2) 4.00
 PR-135 STEEL CUP WASHER 4.00
 RC-20 REVERSIBLE SEAT CUP W/O-RING 5.00

BASS PEDAL PARTS

AL-24A TRACTION PLATE w/SCREWS FOR ELIMINATOR PEDALS \$8.00
 DB-150 DUO-BEAT BEATER w/CONTROL CORE FOR 930 PEDALS 27.00
 DB-100 DUO-BEAT BEATER 29.00
 B-200QB QUAD BEATER 41.00
 B-300F CONTROL CORE BEATER - FELT 52.00
 B-300W CONTROL CORE BEATER - WOOD 52.00
 BCA-1 BELT ASSY COMPLETE FOR ELIMINATOR PEDALS 29.00
 BCA-10 BELT ASSY COMPLETE FOR 1000 SERIES PEDALS 25.00
 BW-100 BEATER WEIGHT - 3 WEIGHTS IN ONE 16.00
 CCA-1 CHAIN ASSY FOR 100 SERIES POWER SHIFTER/POWERPRO 12.00
 CCA-5 CHAIN ASSY FOR ELIMINATOR PEDALS 48.00
 CCA-10 CHAIN ASSY FOR 1000 SERIES PEDALS 23.00
 CAMBK ELIMINATOR BLACK CAM - LINEAR ACTION 15.00
 CAMWT ELIMINATOR WHITE CAM - OVERSIZED LINEAR ACTION 15.00
 CAMBL ELIMINATOR BLUE CAM - PROGRESSIVE ACTION 15.00
 CAMRD ELIMINATOR RED CAM - RADICAL ACTION 15.00
 CAMPL ELIMINATOR PURPLE CAM - AGGRESSIVE ACTION 15.00
 CAMYL ELIMINATOR YELLOW CAM - INVERSE ACTION 15.00
 DC-746A TOE STOPPER ASSEMBLY - P-3000 PEDALS 11.00
 DS-200A DRIVE SHAFT COMPLETE FOR ALL PEARL DOUBLE PEDALS 139.00
 DS-300A DRIVE SHAFT COMPLETE FOR DEMON DRIVE DBL PEDALS 262.00
 EPAP-1 PKG: BEATER WEIGHT, PURPLE CAM, YELLOW CAM 34.00
 KB-508/6 KEY BOLT M5x8MM FOR UNIVERSAL JOINT (6) 5.00
 KB-610/6 KEY BOLT M6x10MM FOR DRIVE SHAFT (6) 5.00
 KB-814/3 KEY BOLT M8x14MM FOR BEATER HOLDER LINK (3) 4.00
 NP-283N/7 TRACTION GRIP DOTS FOR ELIMINATOR PEDALS (7) 5.00
 OL-300 NINJA BEARING OIL 4.00
 PS-300 ANCHOR FOR DEMON DRIVE PEDALS (1 PAIR) 17.00
 SC-363L/12 SCREWS FOR TRACTION PLATE FOR ELIMINATOR PEDALS (4) 9.00
 SP-31F SPRING w/FELT FOR 900 SERIES PEDALS 6.00
 SP-64F SPRING w/FELT FOR ELIMINATOR PEDALS 11.00
 SP-64NF SPRING w/FELT FOR DEMON DRIVE PEDALS 11.00

PEDAL BAGS

DPB-1 SINGLE DEMON DRIVE PEDAL BAG \$81.00
 DPB-2 DOUBLE DEMON DRIVE PEDAL BAG 93.00
 EPB-1 SINGLE ELIMINATOR PEDAL BAG 81.00
 EPB-2 DOUBLE ELIMINATOR PEDAL BAG 93.00

HI-HAT STAND PARTS

SGC-300P SUPER GRIP CLUTCH w/RUBBER WASHERS & LOCK NUT \$34.00
 DCCL-300P DROP CLUTCH w/RUBBER WASHERS & LOCK NUT 42.00
 CL-300P TRIPLE-LOCK CLUTCH w/RUBBER WASHERS & LOCK NUT 22.00
 CL-300 TRIPLE-LOCK CLUTCH w/FELT WASHERS & LOCK NUT 25.00
 HCL-90 STANDARD CLUTCH w/FELT WASHERS 29.00
 HCL-79 STANDARD CLUTCH w/FELT WASHERS 19.00
 NP-208 RUBBER CUP WASHER - MINIMAL-CONTACT 4.00
 NP-210/2 RUBBER CLUTCH WASHERS (2) 4.00
 FE-17 FELT WASHER 4.00
 FL-95/2 FELT CLUTCH WASHERS (2) 6.00
 PR-128 STEEL BOTTOM WASHER 4.00
 HHC-1 SEAT CUP w/TILTER SCREW & SPRING 6.00
 ME-145 21" PULL ROD 7MM DIA 6.00
 ME-145SA 18" PULL ROD 7MM DIA 6.00
 CCA-5H CHAIN ASSY w/END CONNECTORS FOR H-2000/RH-2000 34.00
 CAU-2000 8 FOOT CABLE ASSY FOR RH-2000 139.00

WING BOLTS / WING NUTS

UGB-610/2 WING BOLT M6 x 10MM (2) \$5.00
 UGB-620/2 WING BOLT M6 x 20MM (2) 6.00
 UGB-815/2 WING BOLT M8 x 15MM (2) 5.00
 UGB-820/2 WING BOLT M8 x 20MM (2) 5.00
 UGN-6/2 WING NUT M6 (2) 5.00
 UGN-8/2 WING NUT M8 (2) 5.00
 UGN-8L WING NUT M8 LARGE HANDLE 5.00
 M-8RN/2 KNURLED ROUND NUT M8 (2) 6.00

DRUM KEYS

KGT-100H GYRO TUNE KEY w/QUICK RELEASE NECK STRAP \$23.00
 KMF-300 MULTI-FUNCTION KEY FOR DEMON DRIVE PEDALS 11.00
 K-180 SPIN-TIGHT KEY ALSO FITS STANDARD TENSION RODS 30.00
 K-80 DRUM KEY 7.00
 K-030 HIGH TORQUE KEY 12.00

TENSION RODS / WASHERS / LOCK NUTS

T-055/6 W7/32 x 28MM (1.1") (6/PACK) \$6.00
 T-060/6 W7/32 x 35MM (1.38") (6/PACK) 6.00
 T-061/6 W7/32 x 42MM (1.65") (6/PACK) 6.00
 T-061L/6 W7/32 x 47MM (1.85") (6/PACK) 6.00
 T-062/6 W7/32 x 52MM (2") (6/PACK) 6.00
 T-062F/6 W7/32 x 52MM w/CLAWS FOR SINGLE FLANGE HOOPS (6) 23.00
 T-062L/6 W7/32 x 57MM (2.24") (6/PACK) 6.00
 T-063L/6 W7/32 x 67MM (2.64") (6/PACK) 6.00
 T-065 M6 x 90MM (3.5") FOR BASS DRUMS (1) 4.50
 T-066 M6 x 115MM (4.5") FOR BASS DRUMS (1) 4.00
 T-066X W7/32 x 110MM (4.33") FOR VML BASS DRUMS (1) 4.00
 TR-5100 W7/32 x 110MM (4.33") FOR VBL-VBA-VB-FZH-EXX (1) 4.00
 SPT-5047 W7/32 x 47MM SPIN-TIGHT STAINLESS STEEL (1) 22.00
 SPT-4SPK SPIN-TIGHT STARTER PACK (SPT-5047 x 1, K-180 KEY x 1) 80.00
 SPT-6PK SPIN-TIGHT TENSION ROD PACK (SPT-5047 x 6) 84.00
 SST-5028/6 W7/32 x 28MM (1.1") STAINLESS STEEL (6/PACK) 30.00
 SST-5035/6 W7/32 x 35MM (1.38") STAINLESS STEEL (6/PACK) 30.00
 SST-5038/6 W7/32 x 38MM (1.5") STAINLESS STEEL (6/PACK) 30.00
 SST-5042/6 W7/32 x 42MM (1.65") STAINLESS STEEL (6/PACK) 30.00
 SST-5047/6 W7/32 x 47MM (1.85") STAINLESS STEEL (6/PACK) 30.00
 SST-5052/6 W7/32 x 52MM (2") STAINLESS STEEL (6/PACK) 30.00
 SST-6054 M6 x 54MM (2.12") SS FOR PIPE SNARE DRUMS (1) 6.00
 SST-6115 M6 x 115MM (4.5") SS FOR BASS DRUMS (1) 11.00
 NLW-12B/12 NYLON WASHERS BLACK (12/PACK) 6.00
 MTW-12/12 METAL WASHERS (12/PACK) 4.00
 S-61/12 M5.8 SWIVEL NUT NICKEL PLATED BRASS (12/PACK) 7.00
 S-71/12 M6 SWIVEL NUT NICKEL PLATED BRASS (12/PACK) 9.00
 TL-20/10 TENSION ROD LOCK NUTS (10/PACK) 27.00
 TNK-10N/10 TENSION KEEPER (10/PACK) 11.00

LUGS

BRL-100 MW/REFERENCE SMALL (SPACING 39MM) \$19.00
 BRL-300 MW/REFERENCE LARGE (SPACING 51MM) 20.00
 BRL-55 MW/REFERENCE FOR 5" & 5.5" SNARE DRUMS (SPACING 51MM) 28.00
 BRL-65 MW/REFERENCE FOR 6.5" SNARE DRUMS (SPACING 88MM) 32.00
 ARL-55 ARCH TUBE LUG FOR 5"/5.5" SNARE DRUMS (SPACING 51MM) 30.00
 ARL-65 ARCH TUBE LUG FOR 6.5" SNARE DRUMS (SPACING 88MM) 41.00
 STL-55 SWIVEL TUBE LUG FOR MASTERS PREMIUM 5.5" SNARE DRUMS 37.00
 STL-55L SWIVEL TUBE LUG FOR REFERENCE PURE 5.5" SNARE DRUMS 37.00
 STL-65 SWIVEL TUBE LUG RF PURE & MASTERS PREMIUM 6.5" SNARE 39.00
 NEW STL-100 SWIVEL LUG - MW & HYBRID EXOTICS SNARE DRUMS 12.00
 STL-150 SWIVEL TUBE LUG FOR REFERENCE PURE TOMS 32.00
 STL-300 SWIVEL TUBE LUG FOR REFERENCE PURE BASS DRUMS 37.00
 CL-100 MASTERS MCX SMALL (SPACING 39MM) 9.00
 CL-250 MASTERS MCX LARGE (SPACING 51MM) 12.00
 CL-05 CLASSIC LUG FOR 3" - 4" SNARE DRUMS (SPACING 20MM) 8.00
 CL-55 BRIDGE LUG FOR 5" & 5.5" SNARE DRUMS (SPACING 51MM) 12.00
 CL-65 BRIDGE LUG FOR 6.5" SNARE DRUMS (SPACING 88MM) 13.00
 TB-40 TUBE LUG FOR 4" SNARE DRUMS (SPACING 33MM) 21.00
 TB-50 TUBE LUG FOR 5" SNARE DRUMS (SPACING 51MM) 23.00
 TB-55 TUBE LUG FOR 5.5" SNARE DRUMS (SPACING 63MM) 24.00
 TB-65 TUBE LUG FOR 6.5" SNARE DRUMS (SPACING 88MM) 27.00
 TB-80 TUBE LUG FOR 8" SNARE DRUMS (SPACING 127MM) 27.00
 TLS-55/C VISION FOR 5.5" SNARE DRUMS (SPACING 51MM) 13.00
 TLT-100/C VISION SMALL (SPACING 39MM) 9.00
 TLB-300/C VISION LARGE (SPACING 51MM) 13.00
 NSL-55/C FORUM FZH SNARE DRUM (SPACING 51MM) 8.00
 NSL-100/C FORUM FZH SMALL (SPACING 24MM) 6.00
 NSL-300/C FORUM FZH LARGE (SPACING 32MM) 7.00
 FT-35 FREE FLOATING FOR 3.5" 9.00
 FT-50 FREE FLOATING FOR 5" 12.00
 FT-65 FREE FLOATING FOR 6.5" 14.00
 NEL-55/C EXPORT EXX SNARE DRUM (SPACING 51MM) 8.00
 NEL-100/C EXPORT EXX SMALL (SPACING 24MM) 5.00
 NEL-300/C EXPORT EXX LARGE (SPACING 32MM) 7.00

RUBBER FEET

R-26N/3 D-2500/BR, D-1000N/SN/SPN (3) \$21.00
 R-22N/3 BC-2030, BC-1030, C-1030, S-1030, S-1030L, T/TC-1030 (3) 21.00
 R-20N/3 D-930 (3) 21.00
 R-10/3 C-1000AC, C-1000SC (3) 22.00
 RB-8 H-930, BC-930, C-930, T-930, TC-930 (1) 11.00
 RB-9 S-900, S-930, S930D (1) 7.00
 RB16 S-1030LS, D-730S (1) 7.00
 RB22 H-830, BC-830, C-830, S-830 (1) 7.00
 PL-34 D-790 (1) 2.00

MUFFLERS

OM-1 CLIP-ON MUFFLER FOR SNARE DRUMS & TOMS \$23.00

HOOPS

BASS DRUM HOOPS- WOOD

RIM-18W	18" FOR RF/RFP/MASTERS MAPLE (SPECIFY COLOR)	\$150.00
RIM-20W	20" FOR RF/RFP/MASTERS MAPLE (SPECIFY COLOR)	168.00
RIM-22W	22" FOR RF/RFP/MASTERS MAPLE (SPECIFY COLOR)	178.00
RIM-24W	24" FOR RF/RFP/MASTERS MAPLE (SPECIFY COLOR)	191.00
MCXRIM-18	18" FOR MCX (SPECIFY COLOR)	127.00
MCXRIM-20	20" FOR MCX (SPECIFY COLOR)	138.00
MCXRIM-22	22" FOR MCX (SPECIFY COLOR)	151.00
MCXRIM-24	24" FOR MCX (SPECIFY COLOR)	162.00
BCXRIM-20	20" FOR BCX (SPECIFY COLOR)	95.00
BCXRIM-22	22" FOR BCX (SPECIFY COLOR)	127.00
BCXRIM-24	24" FOR BCX (SPECIFY COLOR)	150.00
SSCRIM-20	20" FOR SSC (SPECIFY COLOR)	111.00
SSCRIM-22	22" FOR SSC (SPECIFY COLOR)	122.00
SSCRIM-24	24" FOR SSC (SPECIFY COLOR)	129.00
VBL-20HP	20" FOR VBL (SPECIFY COLOR)	111.00
VBL-22HP	22" FOR VBL (SPECIFY COLOR)	122.00
VBL-24HP	24" FOR VBL (SPECIFY COLOR)	129.00
EXL-20HP	20" FOR EXL (SPECIFY COLOR)	111.00
EXL-22HP	22" FOR EXL (SPECIFY COLOR)	111.00
EXL-24HP	24" FOR EXL (SPECIFY COLOR)	129.00
EXX-20HP	20" FOR EXX (SPECIFY COLOR)	101.00
EXX-22HP	22" FOR EXX (SPECIFY COLOR)	101.00
EXX-24HP	24" FOR EXX (SPECIFY COLOR)	111.00

DIE CAST HOOPS

DC-0805	8" 5 ROD	\$58.00
DC-1006	10" 6 ROD	63.00
DC-1206	12" 6 ROD	69.00
DC-1306	13" 6 ROD	74.00
DC-1408	14" 8 ROD	79.00
DC-1408S	14" 8 ROD BOTTOM	84.00
DC-1410	14" 10 ROD BATTER SIDE	79.00
DC-1410S	14" 10 ROD SNARE SIDE	79.00
DC-1410SG	14" 10 ROD SNARE SIDE w/GUARD	95.00
DC-1508	15" 8 ROD	84.00
DC-1608	16" 8 ROD	90.00
DC-1808	18" 8 ROD	100.00

FAT TONE HOOPS

FH-0805	8" 5 ROD	\$37.00
FH-1006	10" 6 ROD	37.00
FH-1206	12" 6 ROD	37.00
FH-1306	13" 6 ROD	38.00
FH-1308	13" 8 ROD	38.00
FH-1308S	13" 8 ROD SNARE SIDE	38.00
FH-1408	14" 8 ROD	41.00
FH-1410	14" 10 ROD	41.00
FH-1410S	14" 10 ROD SNARE SIDE	41.00
FH-1508	15" 8 ROD	41.00
FH-1608	16" 8 ROD	47.00
FH-1808	18" 8 ROD	47.00

SUPERHOOP II - 2.3MM

SH-0604	6" 4 ROD	\$22.00
SH-0805	8" 5 ROD	23.00
SH-1006	10" 6 ROD	23.00
SH-1006S	10" 6 ROD SNARE SIDE	23.00
SH-1206	12" 6 ROD	23.00
SH-1208	12" 8 ROD MARCHING	26.00
SH-1208S	12" 8 ROD SNARE SIDE	26.00
SH-1306	13" 6 ROD	29.00
SH-1308	13" 8 ROD MARCHING	29.00
SH-1308S	13" 8 ROD SNARE SIDE	29.00
SH-1308SG	13" 8 ROD SNARE SIDE w/GUARD	29.00
SH-1310B	13" 10 ROD	29.00
SH-1310SG	13" 10 ROD SNARE SIDE w/GUARD	29.00
SH-1408	14" 8 ROD BATTER SIDE	35.00
SH-1408S	14" 8 ROD SNARE SIDE	35.00
SH-1410B	14" 10 ROD BATTER SIDE	35.00
SH-1410S	14" 10 ROD SNARE SIDE	35.00
SH-1410SG	14" 10 ROD SNARE SIDE w/GUARD	35.00
SH-1412B	14" 12 ROD SNARE SIDE	35.00
SH-1412SG	14" 12 ROD SNARE SIDE w/GUARD	35.00
SH-1508	15" 8 ROD	35.00
SH-1608	16" 8 ROD	41.00
SH-1610B	16" 10 ROD	41.00
SH-1610SG	16" 10 ROD SNARE SIDE w/GUARD	41.00
SH-1808	18" 8 ROD	41.00

REGULAR HOOPS - 1.6MM

RH-0804	8" 4 ROD	\$21.00
RH-1006	10" 6 ROD	21.00
RH-1206	12" 6 ROD	21.00
RH-1306	13" 6 ROD	26.00
RH-1408	14" 8 ROD BATTER SIDE	37.00
RH-1408S	14" 8 ROD SNARE SIDE	37.00
RH-1608	16" 8 ROD	46.00
RH-1808	18" 8 ROD	47.00

SINGLE FLANGE HOOPS

SF-13	13" BATTER SIDE	\$42.00
SF-13SG	13" SNARE SIDE w/GUARD	42.00
SF-14	14" BATTER SIDE	42.00
SF-14S	14" SNARE SIDE	42.00
SF-14SG	14" SNARE SIDE w/GUARD	42.00

HEADS

BASS DRUM HEADS w/LOGO - FRONT

SIZE	"MASTERWORKS" COATED P3	"REFERENCE" COATED P3	"MASTERS" CLEAR P3	"MASTERS" COATED P3	"MASTERS" EBONY P3	"PROTONE" EBONY w/PERIMETER EQ	"PROTONE" COATED w/PERIMETER EQ	BLACK BEAT
18"	MWH-18PL \$131.00	P3-1118PL-RF \$71.80	P3-1318PL \$71.80	P3-1118PL \$72.30	P3-1018PL \$82.00	PTH-18PL \$34.00	PTH-18CEQPL \$34.00	EB-18BDPL \$27.00
20"	MWH-20PL 131.50	P3-1120PL-RF 73.80	P3-1320PL 73.80	P3-1120PL 73.80	P3-1020PL 86.10	PTH-20PL 36.00	PTH-20CEQPL 36.00	EB-20BDPL 44.00
22"	MWH-22PL 145.50	P3-1122PL-RF 79.20	P3-1322PL 79.20	P3-1122PL 80.00	P3-1022PL 90.50	PTH-22PL 38.00	PTH-22CEQPL 38.00	EB-22BDPL 51.00
24"	MWH-24PL 145.00	P3-1124PL-RF 84.80	P3-1324PL 84.80	P3-1124PL 84.80	P3-1024PL 95.50	PTH-24PL 43.00	PTH-24CEQPL 43.00	EB-24BDPL 55.00

BASS DRUM HEADS - BATTER

SIZE	"REFERENCE" CLEAR P3	CLEAR P3	PROTONE CLEAR w/PERIMETER EQ	PROTONE COATED w/PERIMETER EQ
18"	P3-1318PL-RF \$71.80	P3-1318PP \$71.80	PTH-18EQ \$34.00	PTH-18CEQ \$34.00
20"	P3-1320PL-RF 73.80	P3-1320PP 73.80	PTH-20EQ 36.00	PTH-20CEQ 36.00
22"	P3-1322PL-RF 79.20	P3-1322PP 79.20	PTH-22EQ 38.00	PTH-22CEQ 38.00
24"	P3-1324PL-RF 84.80	P3-1324PP 84.80	PTH-24EQ 43.00	PTH-24CEQ 43.00

TOM HEADS

SIZE	"REFERENCE" EMPEROR CLEAR	PROTONE CLEAR 2-PLY	PROTONE CLEAR 1-PLY	PROTONE COATED 1-PLY
8"	BE-0308-PL-RF \$24.60	PTH-08D \$17.00	PTH-08 \$8.00	PTH-08C \$12.00
10"	BE-0310-PL-RF 25.90	PTH-10D 19.00	PTH-10 9.00	PTH-10C 13.00
12"	BE-0312-PL-RF 27.70	PTH-12D 21.00	PTH-12 11.00	PTH-12C 13.00
13"	BE-0313-PL-RF 28.40	PTH-13D 23.00	PTH-13 11.00	PTH-13C 15.00
14"	BE-0314-PL-RF 31.00	PTH-14D 24.00	PTH-14 12.00	PTH-14C 16.00
15"	BE-0315-PL-RF 32.50	PTH-15D 25.00	PTH-15 12.00	PTH-15C 18.00
16"	BE-0316-PL-RF 34.10	PTH-16D 32.00	PTH-16 13.00	PTH-16C 21.00
18"	BE-0318-PL-RF 42.80	PTH-18D 34.00	PTH-18 17.00	PTH-18C 24.00

SIZE	MESH HEADS	MESH HEAD PACK
8"	MFH-08 \$9.00	MFH-1222PK \$89.00
10"	MFH-10 12.00	5 PACK FITS 12" 13" 14" 16" 22"
12"	MFH-12 13.00	
13"	MFH-13 14.00	
14"	MFH-14 15.00	
16"	MFH-16 18.00	
18"	MFH-18 16.50	
20"	MFH-20B 28.00	
22"	MFH-22B 33.00	

SNARE DRUM HEADS

SIZE	"REFERENCE" WINDOW COATED AMBASSADOR	COATED BATTER	SNARE HEAD
13"	BA-0113-PL-RF \$28.40	WA-13 \$13.00	SS-13S \$16.00
14"	BA-0114-PL-RF 31.00	WA-14 13.00	SS-14S 18.00

SIGNATURE SERIES CONGAS & BONGOS

BOBBY ALLENDE SIGNATURE CONGAS AND BONGOS

PCF-110DXBA618	11"	FIBERGLASS QUINTO 28" TALL - REMO FIBERSKYN3 HEADS, LOW-RIDER RIMS, POLISHED STEEL HARDWARE	#618 BRISA TROPICAL	\$680.00
PCF-117DXBA618	11 3/4"	FIBERGLASS CONGA 28" TALL - REMO FIBERSKYN3 HEADS, LOW-RIDER RIMS, POLISHED STEEL HARDWARE	#618 BRISA TROPICAL	790.00
PCF-125DXBA618	12 1/2"	FIBERGLASS TUMBA 28" TALL - REMO FIBERSKYN3 HEADS, LOW-RIDER RIMS, POLISHED STEEL HARDWARE	#618 BRISA TROPICAL	845.00
PBF-300DXBA618	7" & 8.5"	FIBERGLASS BONGOS - REMO FIBERSKYN3 HEADS, LOW-RIDER RIMS, POLISHED STEEL HARDWARE	#618 BRISA TROPICAL	470.00
PCF-110DXBA620	11"	FIBERGLASS QUINTO 28" TALL - REMO FIBERSKYN3 HEADS, LOW-RIDER RIMS, POLISHED STEEL HARDWARE	#620 CAFE' CON LECHE	680.00
PCF-117DXBA620	11 3/4"	FIBERGLASS CONGA 28" TALL - REMO FIBERSKYN3 HEADS, LOW-RIDER RIMS, POLISHED STEEL HARDWARE	#620 CAFE' CON LECHE	790.00
PCF-125DXBA620	12 1/2"	FIBERGLASS TUMBA 28" TALL - REMO FIBERSKYN3 HEADS, LOW-RIDER RIMS, POLISHED STEEL HARDWARE	#620 CAFE' CON LECHE	845.00
PBF-300DXBA620	7" & 8.5"	FIBERGLASS BONGOS - REMO FIBERSKYN3 HEADS, LOW-RIDER RIMS, POLISHED STEEL HARDWARE	#620 CAFE' CON LECHE	470.00

RICHIE FLORES SIGNATURE CONGAS & BONGOS

PCW-110DXRF527	11"	THAI OAK QUINTO w/HAND-SELECTED BUFFALO SKINS, CHROME HW	- #527 LUNAR ECLIPSE COLOR-CHANGING FINISH	\$743.00
PCW-117DXRF527	11 3/4"	THAI OAK CONGA w/HAND-SELECTED BUFFALO SKINS, CHROME HW	- #527 LUNAR ECLIPSE COLOR-CHANGING FINISH	854.00
PCW-125DXRF527	12 1/2"	THAI OAK TUMBA w/HAND-SELECTED BUFFALO SKINS, CHROME HW	- #527 LUNAR ECLIPSE COLOR-CHANGING FINISH	921.00
PBW-300DXRF527	7" & 9"	7" & 9" THAI OAK BONGOS w/HAND-SELECTED BUFFALO SKINS, CHROME HW	- #527 LUNAR ECLIPSE COLOR-CHANGING FINISH	555.00

ELITE SERIES CONGAS & BONGOS

NEW PCW-110DXG535	11"	THAI OAK QUINTO w/SELF-ALIGNING WASHER SYSTEM	#535 SATIN BLACK W/GOLD HARDWARE	\$1,055.00
NEW PCW-117DXG535	11.75"	THAI OAK CONGA w/SELF-ALIGNING WASHER SYSTEM	#535 SATIN BLACK W/GOLD HARDWARE	1,165.00
NEW PCW-125DXG535	12.5"	THAI OAK TUMBA w/SELF-ALIGNING WASHER SYSTEM	#535 SATIN BLACK W/GOLD HARDWARE	1,220.00
NEW PBW-300DXG535	7"/9"	THAI OAK BONGOS w/SELF-ALIGNING WASHER SYSTEM	#535 SATIN BLACK W/GOLD HARDWARE	732.00
PCW-110DX532	11"	THAI OAK QUINTO w/SELF-ALIGNING WASHER SYSTEM	#532 CHERRY EUCALYPTUS W/GOLD HARDWARE	1,055.00
PCW-117DX532	11.75"	THAI OAK CONGA w/SELF-ALIGNING WASHER SYSTEM	#532 CHERRY EUCALYPTUS W/GOLD HARDWARE	1,165.00
PCW-125DX532	12.5"	THAI OAK TUMBA w/SELF-ALIGNING WASHER SYSTEM	#532 CHERRY EUCALYPTUS W/GOLD HARDWARE	1,220.00
PBW-300DX532	7"/9"	THAI OAK BONGOS w/SELF-ALIGNING WASHER SYSTEM	#532 CHERRY EUCALYPTUS W/GOLD HARDWARE	732.00
PCF-110DXA641	11"	FIBERGLASS QUINTO 28" TALL w/LOW-RIDER RIMS	#641 BLUE SPARKLE BURST	680.00
PCF-117DXA641	11.75"	FIBERGLASS CONGA 28" TALL w/ LOW-RIDER RIMS	#641 BLUE SPARKLE BURST	790.00
PCF-125DXA641	12.5"	FIBERGLASS TUMBA 28" TALL w/ LOW-RIDER RIMS	#641 BLUE SPARKLE BURST	845.00
PBF-300DXA641	7"/8.5"	FIBERGLASS BONGOS w/LOW-RIDER RIMS	#641 BLUE SPARKLE BURST	470.00

HAVANA SERIES CONGAS & BONGOS

PCF-110HV	11"	FIBERGLASS "FAT BELLY" QUINTO 30" TALL w/LOW-RIDER RIMS	#644 LIQUID GOLD	\$680.00
PCF-117HV	11.75"	FIBERGLASS "FAT BELLY" CONGA 30" TALL w/LOW-RIDER RIMS	#644 LIQUID GOLD	790.00
PCF-125HV	12.5"	FIBERGLASS "FAT BELLY" TUMBA 30" TALL w/LOW-RIDER RIMS	#644 LIQUID GOLD	845.00
PBF-300HV	7"/9"	FIBERGLASS BONGOS w/LOW-RIDER RIMS	#644 LIQUID GOLD	470.00

FOLKLORIC SERIES CONGAS / BONGOS / BATA

TRADITIONAL OAK CONGAS & BONGOS

PCW-110FC526	11"	QUINTO #526 CRIMSON SUNRISE	\$775.00
PCW-117FC526	11.75"	SEGUNDO #526 CRIMSON SUNRISE	830.00
PCW-125FC526	12.5"	TUMBADOR #526 CRIMSON SUNRISE	885.00
PBW-300FC526	7"/8.5"	BONGOS #526 CRIMSON SUNRISE	440.00

BATAS - THAI OAK

PBA-50511	OCONCOLO - SMALL #511 NATURAL	\$775.00
PBA-60511	ITOTELE - MEDIUM #511 NATURAL	830.00
PBA-70511	IYA - LARGE #511 NATURAL	945.00

PRIMERO PRO CONGAS & BONGOS

THAI OAK CONGAS & BONGOS

PWC-302DX	10"/11"	SET w/o STANDS	\$940.00
PWC-202DX	11.75"/12.5"	SET w/o STANDS	765.00
PWB-100DX	7"/8.5"	BONGOS w/ELITE CROWN/HEADS/HW	275.00

COLORS: #511 NATURAL, #521 MIDNIGHT FADE, #523 CARBON VAPOR

FIBERGLASS CONGAS & BONGOS

PFC-302DX	11.75"/12.5"	SET w/o STANDS	\$825.00
PFC-202DX	10"/11"	SET w/o STANDS	635.00
PFB-100DX	7"/8.5"	BONGOS w/ELITE CROWN/HEADS/HW	305.00

COLORS: #621 WINE RED MARBLE, #626 GOLD MARBLE

PRIMERO CONGAS & BONGOS

THAI OAK CONGAS & BONGOS

CONTOUR CROWNS & BLACK POWDER COATED HW

PWC-202511	10"/11"	SET w/o STANDS #511 NATURAL	\$665.00
PWC-203511	10"/11"	SET w/PC-300W STAND #511 NATURAL	785.00
PWC-204511	10"/11"	SET w/PC-100P & PC110P STANDS #511 NATURAL	815.00
PWB-67511	6"/7"	BONGOS #511 NATURAL	175.00

FIBERGLASS CONGAS & BONGOS

CONTOUR CROWNS & BLACK POWDER COATED HW

PFC-202602	10"/11"	SET w/o STANDS #602 BISTRE BLACK	\$479.00
PFC-202631	10"/11"	SET w/o STANDS #631 EBONY	479.00
PFC-203602	10"/11"	SET w/PC-300W STAND #602 BISTRE BLACK	549.00
PFC-204602	10"/11"	SET w/PC-100P & PC110P STANDS #602 BISTRE BLACK	579.00
PFB-100602	6"/7"	BONGOS #602 BISTRE BLACK	175.00
PFB-100631	6"/7"	BONGOS #631 EBONY	175.00

TRAVEL CONGAS

PTC-1100	11"	w/REMO FIBERSKYN3 HEAD - 3.5" DEEP	\$410.00
PTC-1175	11.75"	w/REMO FIBERSKYN3 HEAD - 3.5" DEEP	440.00
PTC-1250	12.5"	w/REMO FIBERSKYN3 HEAD - 3.5" DEEP	475.00

CAJONS

NEW PBC-1914M3	MACH 3 CAJON w/ 3 ISOLATED PLAYING ZONES 100% BIRCH (USA)	\$759.00
NEW PBC-511ABC	AFTERBURNER CAJON w/DUAL REAR BASS PORTS 100% BIRCH (USA)	415.00
PBC-1914SBS	SONIC BOOM BUZZ CAJON w/SNARES, BASS PORT & ANGLED WALNUT FRONT PLATE (USA)	559.00
PBC-1914SB	SONIC BOOM CAJON w/BASS PORT & ANGLED FRONT PLATE (USA)	499.00
NEW PCJ-650CG	CENTIGRADE CAJON w/100 DEGREES OF TILT #650 MANGO CHERRY BURST	499.00
PCJ-IC645	INNER CIRCLE MULTI-FUNCTION CAJON/CONGA - INCLUDES STRAP #645 TEQUILA SUNRISE, #648 BURNT ORANGE TURBO STRIPE	499.00
PCJ-3000B	THE WEDGE TRI-SIDE CAJON - ERGO SHAPE FOR EASY PLAYING	499.00
PBC-509JD	JESUS DIAS SIGNATURE RADIAL EDGE CAJON 12.4"x12.4"x19.4" #509 ARTISAN ROSEWOOD	443.00
PBC-512TF	TWO-FACE CAJON - 3MM & 5MM WOOD FACES FOR TWO DIFFERENT SOUNDS 18.8"x12.4"x12.4"	419.00
PCJ-647CYC	CYCLONE CAJON FIBERGLASS BODY w/CURVED BACK & BOOM PORT #647 DARK CHOCOLATE	399.00
PFC-629S	CUBE CAJON w/TWO-HEIGHT STAND - 5 DIFFERENT TONES 12.62"x12.62"x12.62" #648 CARUBINGA	399.00
PCJ-633BB630	BOOM BOX FIBERGLASS CAJON w/PORTED CHAMBER FOR SUPER-LOW BASS 12"x12"x18.9" #630 RED SPARKLE	399.00
PCJ-633BT	BRUSH BEAT BOOM BOX FIBERGLASS CAJON w/PORTED CHAMBER FOR SUPER-LOW BASS 12"x12"x18.9" BLACK/WHITE FINISH	399.00
PCJ-633BB	BOOM BOX FIBERGLASS CAJON w/PORTED CHAMBER FOR SUPER-LOW BASS 12"x12"x18.9" #633 ARTISAN RED MAHOGANY	332.00
PCJ-629	JINGLE BOX CAJON 12"x12"x18.9" #629 CARUBINGA	332.00
PBC-507JC	JINGLE BOX CAJON - WOOD w/SNARES	332.00
PTCJ-1265	TRAVEL CAJON 12"x6.5"	310.00
PBC-507	BOX CAJON 12"x12"x18.9" #507 GYPSY BROWN	245.00
PBC512CC	CLUB CAJON - WOOD w/PORTED CHAMBER & FIXED SNARES	189.00
PFB-300	FUN BOX CAJON - IDEAL FOR THE TRAP PROGRAM 10"x9.45"x13.4"	180.00

DJEMBES

PJW-140R533	14" THAI OAK EZ TUNE ROPE LOOK w/MECHANICAL TUNING, GOAT SKIN HEADS, STRAP INCLUDED #533 GLOSS BLACK w/RED ROPES	\$610.00
PJW-125R533	12.5" THAI OAK EZ TUNE ROPE LOOK w/MECHANICAL TUNING, GOAT SKIN HEADS, STRAP INCLUDED #533 GLOSS BLACK w/RED ROPES	565.00
PJF-350RX632	14" FIBERGLASS EZ TUNE ROPE LOOK w/MECHANICAL TUNING, GOAT SKIN HEADS, STRAP INCLUDED #632 CRANBERRY FADE	515.00
PJF-320RX632	12.0" FIBERGLASS EZ TUNE ROPE LOOK w/MECHANICAL TUNING, GOAT SKIN HEADS, STRAP INCLUDED #632 CRANBERRY FADE	405.00
PJW-340511	12.5" THAI OAK w/CONTOUR CROWN, GOAT SKIN HEADS, STRAP INCLUDED #511 NATURAL	885.00
PJF-320602	12.5" FIBERGLASS w/CONTOUR CROWN, GOAT SKIN HEADS, STRAP INCLUDED #602 BISTRE BLACK	550.00
PJF-350602	14" FIBERGLASS w/CONTOUR CROWN, GOAT SKIN HEADS, STRAP INCLUDED #602 BISTRE BLACK	770.00
PJF-310602	9.5" FIBERGLASS #602 BISTRE BLACK	329.00
PFD-300	FUN DRUM LIGHTWEIGHT FIBERGLASS DJEMBE w/SHOULDER STRAP, GREAT FOR THE TRAP PROGRAM	220.00

FRAME DRUMS

PHC-STRP	HIP CLIPZ STRAP w/CLIPS	\$32.00	PFR-0818C	SET: 8",10",12",14",16",18" TUNABLE FRAME DRUMS (COATED HEADS)	\$499.00
PHC-SNR	HIP CLIPZ SNARE SLAP	49.00	PFR-0818	SET: 8",10",12",14",16",18" TUNABLE FRAME DRUMS (SMOOTH HEADS)	499.00
PHC-PK	HIP CLIPZ STRAP & SNARE SLAP (SET)	79.00	PFR-14C	14" TUNABLE FRAME DRUM w/COATED HEAD	89.00
			PFR-14HK	14" THE "HIPKIT" w/HIP CLIPZ STRAP & SNARE SLAP	165.00

TIMBALES

ETE-1415MQ	STEEL 14x7"/15x7" MARC QUINONES 5 LUGS, QUICK ATTACH COWBELL POST, REMO AMBASSADORS, DBL BR. TILTING STAND, PBL-30 CLAVE BLOCK	\$880.00
PTE-1415MQ	STEEL 14x7"/15x7" MARC QUINONES PRIMERO BLACK POWDER COATED FINISH, 5 LUGS, PT-800W TILTING STAND	739.00
PTE-1415DX	STEEL 14x7"/15x7" PRIMERO PRO w/TILTING STAND	615.00
PTS-5134	STEEL 13x6.5"/14x6.5" PRIMERO w/TILTING STAND, STICKS & COWBELL	579.00
PTE-1336	STEEL 13x7" PRIMERO w/PPS-36 MOUNTING CLAMP	240.00
PTE-3131	STEEL 13x3" PRIMERO FLAT TIMBALE w/I.S.S.	189.00

STANDS

PC-3000TW	QUICK STAND DOUBLE CONGA STAND w/CASE	\$285.00	TRAVEL CONGA STANDS		
PC-900	ALL-FIT CONGA STAND ADJ. HEIGHT & TILT	150.00	PC-1100TC	TRAVEL CONGA STAND w/BAG FOR 11"	\$275.00
PC-300W	QUICK RELEASE DOUBLE CONGA STAND	120.00	PC-1175TC	TRAVEL CONGA STAND w/BAG FOR 11.75"	275.00
PC-2500	ULTRA LITE BASKET STAND	165.00	PC-1250TC	TRAVEL CONGA STAND w/BAG FOR 12.5"	275.00
PC-100P	BASKET STAND FOR 10" PRIMERO ADJ. HEIGHT	75.00	PPS-50TC	STAND BRIDGE CONNECTS STANDS FOR STABILITY	49.00
PC-110P	BASKET STAND FOR 11" PRIMERO ADJ. HEIGHT	75.00	DJEMBE STANDS		
BONGO STANDS			PC-800S	SINGLE-BRACED DJEMBE STAND FITS ALL DJEMBES	\$189.00
PB-900LW	LIGHTWEIGHT FITS VIRTUALLY ALL BONGOS	\$200.00	TIMBALE STAND w/DBL BR. LEGS		
PB-700	SGL. BR. LEGS NEW FIT-ALL CLAMPING SYSTEM	129.00	PT-900W	TILTING STAND w/NO VIBRATION COWBELL MOUNT	\$199.00
PB-700BHS	BONGO ATTACHMENT FOR PC-200W	75.00	CAJON STAND		
PB-900BH	BONGO UPPER TUBE w/STRAP FOR RACKS, ETC.	110.00	PCJ-70STD	TILTING STAND w/ADJUSTABLE ARMS - VERY VERSATILE	\$239.00

HOLDERS & ACCESSORIES

HOLDERS		BOX CAJON ACCESSORIES			
PCS-10	COWBELL STACKER	\$35.00	PBCW-100	WOOD BLOCK w/DUAL-LOCK TAPE & MTG BRK	\$62.00
PGB-10	GOCK BLOCK HOLDER	29.00	PBCC-100	CLAVE BLOCK w/DUAL-LOCK TAPE & MTG BRK	54.00
PJBS-350	DJEM-BASS CONVERTS 14" DJEMBE TO BASS DRUM	140.00	PSC-BC	SEAT CUSHION w/THICK FOAM FOR COMFORT	35.00
PPS-10	STIX-FREE (SMALL) PLAY COWBELLS WITHOUT STICKS	45.00	PJCP-1	JINGLE CUPS 1 SET OF BRASS & STEEL JINGLES	24.00
PPS-11	STIX-FREE (LARGE) PLAY COWBELLS WITHOUT STICKS	45.00	PJCP-1/6	JINGLE CUPS 6 SETS OF BRASS & STEEL JINGLES	160.00
PPS-35	ANGLED SINGLE POST HOLDER	30.00	PCB-DL	DUAL-LOCK TAPE FOR PBCW-100 & PBCC-100	9.00
PPS-37	ADJUSTABLE HOLDER w/QUICK RELEASE ADAPTER	49.00	CAJH-100	CAJON HOLSTER	45.00
PPS-40	LUG MOUNT HOLDER	55.00	CONGA ACCESSORIES		
PPS-81	RACK 12" 4 STRAIGHT POSTS & 2 "Z" POSTS	79.00	PRP-140	CONGA RESOPLATE MAXIMIZES RESONANCE	\$54.00
PPS-82	RACK 18" 4 STRAIGHT POSTS & 2 "Z" POSTS	99.00			
PPS-20	FOOT PEDAL BRACKET	85.00			
PPS-20L	FOOT PEDAL BRACKET w/LONG "L" ROD	87.00			

TRAP TABLES

PTYB-1212	TOY BOX CARRYING CASE/TRAP TABLE	\$175.00
PTT-1212	12"X12" TRAP TABLE	85.00
PTT-1824	18"X24" TRAP TABLE w/SGL BRACED STAND	240.00
PTT-1824W	18"X24" TRAP TABLE w/DBL BRACED STAND	275.00
PTT-1523MP	MALLET/STICK/TRAP TRAY w/CLAMP 12"x23"	229.00
PTT-1215MP	MALLET/STICK/TRAP TRAY w/CLAMP 12"x15"	219.00
PTR-1824	PERC. RACK ADD-ON FOR PTT-1824	285.00
PTR-1824RC1	ROD & CLAMP ADD-ON FOR PTR-1824 STRAIGHT	20.00
PTR-1824RC2	ROD & CLAMP ADD-ON FOR PTR-1824 ANGLED	25.00
PTR-1824RC3	SINGLE POST ADAPTER FOR PTT-1824/PTT-1212	35.00
PTR-UNV	"UNIVERSAL-FIT" TRAP TABLE RACK FITS MANY BRANDS & SIZES OF TRAP TABLES	200.00

ANARCHY SERIES

PCB-20	HEAVY METAL COWBELL "BRUTAL, CUTTING TONE"	\$46.00
PAR-100	HEAVY METAL CRASHER "WHITE NOISE BLAST"	87.00
PBL-100	HEAVY METAL BLOCK "SKULL CRUSHING SHOT"	50.00

COWBELLS

HORACIO HERNANDEZ SIGNATURE COWBELLS II		
HH-1X	BELLA (HIGH-PITCH CHA CHA) w/QUICK RELEASE BRACKET	\$59.00
HH-2X	CLABELL (FOOT CLAVE BELL) w/QUICK RELEASE BRACKET	67.00
HH-3X	CHABELLA (LOW-PITCH CHA CHA) w/QUICK RELEASE BRACKET ..	70.00
HH-4X	ISABELL (MAMBO BELL) w/QUICK RELEASE BRACKET	75.00
HH-5X	MARYBELL (TIMBALE BELL) w/QUICK RELEASE BRACKET	82.00

BALA BELLS

BCM-10	MOUNTED CAMPANA BELL	\$82.00
BCH-10	HAND-HELD CAMPANA BELL LOW-PITCHED	68.00

NEW YORKER BELLS - ONE PIECE CONSTRUCTION

BCM-3NY	CHA CHA HI-PITCHED	\$65.00
BCM-5NY	CHA CHA LOW-PITCHED	65.00
BCM-7NY	MAMBO	76.00
BCM-8NYQ	TIMBAL MARC QUINONES SIGNATURE BELL	84.00

TRI-BELLS

PTA-30	TRI-AGOGO PLAYED HAND-HELD OR MOUNTED	\$98.00
PTB-30	TRI-BELLS PLAYED HAND-HELD OR MOUNTED	89.00

AGOGO BELLS

ECB-22	HAND-HELD AGOGO	\$43.00
ECB-23	MOUNTED AGOGO	51.00

PRIMERO COWBELLS

PCB-4	4" BELL	\$21.00
PCB-6	6" BELL	25.00
PCB10	PRIMERO ROCK COWBELL	32.00
<i>NEW</i> PCB10MCR	PRIMERO ROCK BELL S.E. MILLENNIUM CHROME	40.00
PCB-1030	ROCK BELL w/PPS-30 MOUNT	50.00

COWBELL BEATERS

PDC-10	DUAL COWBELL BEATER w/RUBBER & WOOD SIDES	\$15.00
PDC-60	PRO COWBELL BEATER	19.00

BRAZILIAN PERCUSSION

PBCX-1204	12"x4" CAIXA (SNARE DRUM)	\$185.00
PBCX-1265	12"x6.5" CAIXA (SNARE DRUM)	205.00
PBS-2222	22"x22" SURDO	605.00
PBS-2018	20"x18" SURDO	570.00
PBS-1822	18"x22" SURDO	550.00
PBSM-20	SURDO MALLET	24.00
PBS-30BD	LEGS & BD ADAPTOR KIT FOR SURDO	130.00
PBS-22H	22" REPLACEMENT SURDO HEAD	150.00
PBS-20H	20" REPLACEMENT SURDO HEAD	130.00
PBS-18H	18" REPLACEMENT SURDO HEAD	120.00
PBR-10S	10" STEEL REPINIQUE w/STRAP	250.00
PBR-12S	12" STEEL REPINIQUE w/STRAP	295.00

PBC-80SS	STEEL CUICA	\$220.00
PBC-80S	CUICA STICK	6.60
PBC-80H	8" CUICA GOATSKIN HEAD	60.00
PBT-60C	TAMBORIM w/QUICK DRAW MOUNT	85.00
PBT-70S	TAMBORIM STICK w/AUTHENTIC 7-BRISTLE DESIGN	25.00
PBP-510	10" PANDEIRO w/BAG (GOATSKIN HEAD)	150.00
PBP-612	12" PANDEIRO w/BAG (PLASTIC HEAD)	150.00
PDZ-510	PANDANZA w/AGOGO BELL	160.00
PBRC-80	ROCAR	130.00
PBTB-140	TIMBAO w/STRAP (BRAZILIAN CONGA DRUM)	470.00
PBTA-1420	14" TAN TAN (HAND SURDO)	305.00

FIELD PERCUSSION

TAIKO

<i>NEW</i> WST-20FP	SHIME TAIKO w/TENSION RODS REMO HEADS	\$1,359.00
---------------------	---	------------

DJEMBE

<i>NEW</i> PJF-350FP649*	14" DJEMBE FIBERGLASS w/NUSKYN REMO HEADS	\$640.00
--------------------------	---	----------

*#649 TEXTURED BLACK FINISH FOR OUTDOORS

SHAKER

<i>NEW</i> PGA-60FP*	FIELD PERCUSSION SHAKER 21" w/CHAMBERED CENTER ...	\$85.00
----------------------	--	---------

CONGA - SET

<i>NEW</i> PFC-202EDU649*	10"/11" FIBERGLASS CONGA SET w/PC-300 STAND	\$640.00
---------------------------	---	----------

BANDA PERCUSSION

TAMBORA

<i>NEW</i> PBTB-2418/C33	BANDA TAMBORA w/STAND CYM HOLDER & BEATER #33 PURE WHITE	\$799.00
--------------------------	--	----------

TIMBALES

<i>NEW</i> PBTM-1516C	15X10"/16X10" STEEL w/TILTING STAND	\$385.00
-----------------------	---	----------

BAGS

PTYB-1212	TOY BOX CARRYING CASE/TRAP TABLE	\$175.00
PSC-110CG	CONGA BAG FOR 11"	175.00
PSC-117CG	CONGA BAG FOR 11.75"	175.00
PSC-125CG	CONGA BAG FOR 12.5"	175.00
PPB-100	FIT ALL CONGA BAG	83.00
PSC-1175TC	TRAVEL CONGA BAG - FITS ALL 3 SIZES OF TRAVEL CONGAS	90.00
PSC-BB	BONGO BAG	110.00
PSC-125DJ	DJEMBE BAG FOR 12.5"	140.00
PSC-140DJ	DJEMBE BAG FOR 14"	140.00

PSC-1213CJ	BOX CAJON BAG - FITS ALL PEARL BOX CAJONS	\$98.00
PSC-2222BS	SURDO BAG FOR 22"x22"	305.00
PSC-1822BS	SURDO BAG FOR 18"x22"	275.00

HAND PERCUSSION

AGO-SHA AGOGO+SHAKER

PAS-50	AGO-SHA w/SINGLE AGOGO BELL	\$45.00
PAS-100	AGO-SHA w/HIGH & LOW AGOGO BELLS	65.00

BLOCKS

PBL-10	HIGH CLAVE BLOCK w/HOLDER (NEON GREEN)	\$55.00
PBL-20	MEDIUM CLAVE BLOCK w/HOLDER (NEON YELLOW)	55.00
PBL-30	LOW CLAVE BLOCK w/HOLDER (NEON ORANGE)	55.00
PAB-20	ASH TONE BLOCK HI-PITCH	36.00
PAB-50	ASH TONE BLOCK MED-PITCH	43.00
PAB-100	ASH TONE BLOCK LOW-PITCH	50.00
PCWB-100A	ELITE CONCERT WOOD BLOCKS w/MOUNT (2x2x6")	54.00
PCWB-200A	ELITE CONCERT WOOD BLOCKS w/MOUNT (3x3x9")	62.00
PCWB-300A	ELITE CONCERT WOOD BLOCKS w/MOUNT (4x4.5x10")	73.00
PCWTB-05	TEMPLE BLOCK SET (SET OF 5)	449.00

CABASA

ONE-HANDED OPERATION

CBS-100	"GATLING" CABASA w/HOLDER	\$140.00
---------	---------------------------------	----------

CASTANETS - CHIN CHAN WOOD

PCN-20S	CASTANETS w/BAG - SHORT HANDLES	\$93.00
PCN-20H	CASTANETS HOLDER	54.00

CLAVES

PCL-10	FIBER CLAVES - VERY CUTTING SOUND	\$40.00
PCL-10FCB	TRADITIONAL CLAVES - BAMBOO	24.00
PCL-20FCW	FOLKLORE CLAVES - WOOD	29.00

FOLKLORE TRADITIONAL PERCUSSION

PCA-14FC	TRADITIONAL CATA' w/HOLDER 13" - 16" BAMBOO	\$61.00
PAC-10FC	TRADITIONAL ACHERE w/HANDLE - LOUD SINGLE SHAKER	36.00
PGT-10FC	TRADITIONAL GUATACA PLAYED HANDHELD OR MOUNTED	73.00

GUIROS / GUIRO HOLDER

PFG-20	FIBER GUIRO w/GOURD & METAL SURFACES w/STICKS	\$95.00
PMG-20	METAL GUIRO PERFECT FOR MERENGUE RHYTHMS	85.00
PNG-20	NATURAL GOURD GUIRO	105.00
PGH-20	UNIVERSAL GUIRO HOLDER INCLUDES 3/8" Z-ROD	65.00

JINGLE RING

PJH-10SH	HI-HAT JINGLE RING w/20 PAIRS OF STAINLESS STEEL JINGLES	\$75.00
----------	--	---------

LOG DRUM

MAHOAGANY TOP ACACIA WOOD BODY 2 PITCHES PER DRUM

<i>NEW</i> PCW-LD25	25"x6"x6" CONCERT LOG DRUM w/ AIR SUS RUBBER FEET	\$499.00
<i>NEW</i> PCW-LD30	30"x6"x6" CONCERT LOG DRUM w/ AIR SUS RUBBER FEET	\$65.00

MARACAS

PFM-20	BEADED MARACAS w/SHEKERE-TYPE BEADS	\$40.00
PRM-20	NATURAL HIDE MARACAS	109.00
PFM-50	"MARACABASA" MARACAS & CABASA IN ONE	60.00

RATTLER

PRT-10	RATTLER	\$73.00
PRT-10C	RATTLER CLAMP	80.00

SHEKERE

PSK-10	FIBERGLASS SHEKERE	\$199.00
PSK50FC	TRADITIONAL NATURAL GOURD SHEKERE - UNO (SM)	165.00
PSK60FC	TRADITIONAL NATURAL GOURD SHEKERE - SEGUNDO (MED) ..	185.00
PSK70FC	TRADITIONAL NATURAL GOURD SHEKERE - CAJA (LG)	220.00

SHEKERE

PSK-10	FIBERGLASS SHEKERE	\$199.00
PSK50FC	TRADITIONAL NATURAL GOURD SHEKERE - UNO (SM)	165.00
PSK60FC	TRADITIONAL NATURAL GOURD SHEKERE - SEGUNDO (MED) ..	185.00
PSK70FC	TRADITIONAL NATURAL GOURD SHEKERE - CAJA (LG)	220.00

SHAKERINE SHAKER + TAMBOURINE

PSR-03	SHAKERINE	\$99.00
PSR-01	MINI-SHAKERINE w/TAMBOURINE JINGLES	35.00
PGR-03	GANZEIRO - COMBINATION PANDEIRO & SHAKER	70.00
PGR-01	MINI-GANZEIRO w/PANDEIRO JINGLES	40.00

SHAKERS

PGA-20	BASKET GANZA 9"x4"	\$25.00
PGA-30	HEX GANZA (SHORT) PRODUCES FOUR PITCHES	30.00
PGA-32	HEX GANZA (LONG) PRODUCES FOUR PITCHES	30.00
PGA-40	TRIPLE-SHAKER "SHAKE - CLICK - SWISH" SOUNDS	55.00
PGA-50SF	GROOVE-SHAKER ATTACHES TO DRUM STICKS	40.00
PEC-1	EGG CARTON SINGLE TUBE w/3 EGGS	25.00
PEC-1/6	EGG CARTON SIX PEC-1 TUBES	150.00
PWR-40	"SHAKELETS" - BRACELET w/SHAKERS (1 PR)	55.00

SLAP STICK

PSS-100	SLAP STICK	\$55.00
---------	------------------	---------

SPIRIT CHIMES

CAN BE MOUNTED OR HAND-HELD - MOUNT INCLUDED

PSC-30	SPIRIT CHIMES w/3 TONES, INCLUDES HOLDER & Mallet	\$55.00
--------	---	---------

TAMBOURINES / TOMBOURINES

PETM-1017	SYMP. TAMBOURINE w/BAG w/17 PR. STAMPED BRASS JINGLES	\$150.00
PTM-10GH	TAMBOURINE w/QUICKMOUNT - BRASS JINGLES	75.00
PTM-10SH	TAMBOURINE w/QUICKMOUNT - STAINLESS STEEL JINGLES	55.00
PTH-10S	10" HEADLESS TAMBOURINE - STAINLESS STEEL JINGLES	55.00
PTH-10B	10" HEADLESS TAMBOURINE w/BRASS JINGLES	85.00
PETM-20	ELITE CONCERT TAMBOURINE w/CASE (DOUBLE ROW)	120.00
PTB-10	10" TOMBOURINE w/QUICKMOUNT	120.00
PTM-50SHR	ULTRA-GRIP w/ADJUSTABLE VOLUME & STEEL JINGLES	70.00
PTM-50BHR	ULTRA-GRIP w/ADJUSTABLE VOLUME & BRASS JINGLES	85.00
<i>NEW</i> PTM-09BK	9" OVAL TAMBOURINE w/MILLENNIUM CHROME JINGLES	65.00

TRIANGLES & TRIANGLE HOLDERS

PET60	6" ELITE CONCERT TRIANGLE w/BEATER & CASE	\$65.00
PET80	8" ELITE CONCERT TRIANGLE w/BEATER & CASE	75.00
PET100	10" ELITE CONCERT TRIANGLE w/BEATER & CASE	85.00
PETB-30	ELITE CONCERT TRIANGLE BEATERS w/CASE - SET OF 3	35.00
PTC-10	TRIANGLE CLIP	20.00
PTC-300	TRIO TRIANGLE HOLDER	110.00
PPS-12T	STIX-FREE TRIANGLE HOLDER w/8" TRIANGLE	120.00

TANG-TANG

SHAKER w/CAXIXI STYLE PLATE & WOODEN "CLACKER"

PTG-20	TANG-TANG HIGH & LOW SET	\$68.00
--------	--------------------------------	---------

WINDCHIMES

STACKABLE TO CREATE MULTIPLE ROW WINDCHIMES

PWCH-3220A	32 BAR ALUMINUM w/HOLDER, STRIKER & CASE	\$239.00
PWCH-3220G	32 BAR GOLD ANODIZED ALUM. w/HOLDER, STRIKER & CASE	249.00
PWCH-3620A	36 BAR ALUMINUM CHROMATIC w/HOLDER, STRIKER & CASE	275.00
PWC-32A	32 BAR ALUMINUM w/STRIKER	179.00

REPLACEMENT HEADS & PARTS

PH100WDX	10" ELITE WOOD RE-QUINTO REPLACEMENT HEAD	\$65.00
PH110WDX	11" ELITE WOOD QUINTO REPLACEMENT HEAD	69.00
PH117WDX	11.75" ELITE WOOD CONGA REPLACEMENT HEAD	75.00
PH125WDX	12.5" ELITE WOOD TUMBA REPLACEMENT HEAD	79.00
PH140WDX	14" ELITE WOOD SUPER TUMBA REPLACEMENT HEAD	85.00
PH70WDX	7" ELITE WOOD BONGO REPLACEMENT HEAD	48.00
PH90WDX	9" ELITE WOOD BONGO REPLACEMENT HEAD	54.00
PH340W	12.5" ELITE WOOD DJEMBE REPLACEMENT HEAD	89.00
PH125RD	12.5" EZ TUNE WOOD DJEMBE REPLACEMENT HEAD	105.00
PH140RD	14" EZ TUNE WOOD DJEMBE REPLACEMENT HEAD	130.00
PH110F	11" ELITE FIBER QUINTO REPLACEMENT HEAD	69.00
PH117F	11.75" ELITE FIBER CONGA REPLACEMENT HEAD	75.00
PH125F	12.5" ELITE FIBER TUMBA REPLACEMENT HEAD	79.00
PH70F	7" ELITE FIBER BONGO REPLACEMENT HEAD	48.00
PH90F	9" ELITE FIBER BONGO REPLACEMENT HEAD	54.00
PH320F	12.5" ELITE FIBER DJEMBE REPLACEMENT HEAD	89.00
PH350F	14" ELITE FIBER DJEMBE REPLACEMENT HEAD	99.00
PH320RX	12" EZ TUNE FIBER DJEMBE REPLACEMENT HEAD	120.00
PH350RX	14" EZ TUNE FIBER DJEMBE REPLACEMENT HEAD	150.00
PH110WFCE	11" ELITE HEAD FOR FOLKLORE QUINTO	119.00
PH117WFCE	11.75" ELITE HEAD FOR FOLKLORE CONGA	129.00
PH125WFCE	12.5" ELITE HEAD FOR FOLKLORE TUMBA	135.00
PH70WFCE	7" ELITE HEAD FOR FOLKLORE BONGO	79.00
PH850WFCE	8.5" ELITE HEAD FOR FOLKLORE BONGO	89.00

PH110WFC	11" FOLKLORE QUINTO REPLACEMENT HEAD	\$119.00
PH117WFC	11.75" FOLKLORE CONGA REPLACEMENT HEAD	129.00
PH125WFC	12.5" FOLKLORE TUMBA REPLACEMENT HEAD	135.00
PH70WFC	7" FOLKLORE BONGO REPLACEMENT HEAD	79.00
PH850WFC	8.5" FOLKLORE BONGO REPLACEMENT HEAD	89.00
M41106TCPL	11" FIBERSKYN HEAD - TRAVEL/ALLENDE/FLORES CONGAS (w/TRAVEL CONGA LOGO)	87.60
M41175TCPL	11.75" FIBERSKYN HEAD - TRAVEL/ALLENDE/FLORES CONGAS (w/TRAVEL CONGA LOGO)	91.70
M41250TCPL	12.5" FIBERSKYN HEAD - TRAVEL/ALLENDE/FLORES CONGAS (w/TRAVEL CONGA LOGO)	97.60
PH100PW	10" PRIMERO WOOD QUINTO REPLACEMENT HEAD	49.00
PH110PW	11" PRIMERO WOOD CONGA REPLACEMENT HEAD	53.00
PH60PW	6" PRIMERO WOOD BONGO REPLACEMENT HEAD	30.00
PH70PW	7" PRIMERO WOOD BONGO REPLACEMENT HEAD	31.00
PH850PW	8.5" PRIMERO WOOD BONGO REPLACEMENT HEAD	35.00
PH100PF	10" PRIMERO FIBER QUINTO REPLACEMENT HEAD	49.00
PH110PF	11" PRIMERO FIBER CONGA REPLACEMENT HEAD	53.00
PH60PF	6" PRIMERO FIBER BONGO REPLACEMENT HEAD	30.00
PH70PF	7" PRIMERO FIBER BONGO REPLACEMENT HEAD	48.00
PH310F	9.5" FIBER MINI-DJEMBE REPLACEMENT HEAD	54.00
PL110DX	ELITE CONGA LUG	10.00
PL70DX	ELITE BONGO LUG	10.00
PCH01WC	CARRYING HANDLE FOR ELITE MODEL CONGAS	20.00
PSMB01W	STAND MOUNTING BRACKET FOR ELITE CONGAS	11.00
PL100P	PRIMERO CONGA LUG	9.00
PL70P	PRIMERO BONGO LUG	9.00
<i>NEW</i> TK-1410N2	SHIME TAIKO HEAD	353.00

MARCHING CARRIERS & STANDS

PEARL CX AIR FRAME CARRIERS

CXS-1	SNARE CARRIER - SUPERLIGHT FOR COMFORT, ACS WAIST BELT - INCLUDES CXSA-2 SNARE ATTACHMENT	\$440.00
CXT-1	TENOR CARRIER - SUPERLIGHT FOR COMFORT, ACS WAIST BELT - INCLUDES CXBB-1/B BACKBAR	490.50
CXB-1	BASS CARRIER - SUPERLIGHT FOR COMFORT, ACS WAIST BELT FOR AGILITY, CONTROL AND SUPPORT	440.00
NEW CXSA-2	SNARE ATTACHMENT 12% LIGHTER W/ 30+ DEGREES OF DOWN ANGLE ADJ FOR CXS-1 AND MXSP-1 SNARE CARRIERS	86.00
NEW CXBB-1/B	BACKBAR (ONLY) w/BLACK FINISH FOR CXT-1 TENOR CARRIER.....	178.00
NEW BBS-68/B	6" & 8" TOM MOUNTING ATTACHMENT SET w/BLACK FINISH.....	31.00
NEW BBS-6S	6" TOM MOUNTING ATTACHMENT w/BOLTS & NUTS w/BLACK FINISH.....	23.50
NEW BBS-8/B	8" TOM MOUNTING ATTACHMENT w/BOLTS & NUTS w/BLACK FINISH.....	11.00
AL-84A	SHOULDER BACKPLATE ASSEMBLY COMPLETE	24.00
NP-479NL	SHOULDER CUSHION (LEFT) FOR CX CARRIERS	37.00
NP-479NR	SHOULDER CUSHION (RIGHT) FOR CX CARRIERS	37.00
NP-478N	BELLY PLATE CUSHION (ONLY) FOR CX CARRIERS	29.50
NP-492A	ACS BELT W/CUSHION FOR CX CARRIERS	36.00

PEARL PIPE DRUM CARRIERS

CXSP-1	CX PIPE SNARE CARRIER, INCLUDES CXSA-2 SNARE ATTACHMENT	\$474.00
MXSP-1	MX PIPE SNARE T-CARRIER, INCLUDES CXSA-2 SNARE ATTACHMENT	321.50

PEARL MX T-FRAME CARRIERS

MXS-1	SNARE T-CARRIER, INCLUDES MXSA-1/B SNARE ATTACHMENT	\$271.00
MXT-1	QUAD T-CARRIER, INCLUDES MX4BB-1/B BACKBAR	333.00
MXT3-1	TRIO T-CARRIER, INCLUDES MX3BB-1/B BACKBAR	304.50
MXB-1	BASS T-CARRIER	231.50
NEW MXSA-1/B	SNARE ATTACHMENT w/BLACK FINISH FOR MXS-1 SNARE CARRIER	76.00
NEW MX3BB-1/B	BACKBAR (ONLY) w/BLACK FINISH FOR MXT3-1 TRIO TOM CARRIER	79.00
NEW MX4BB-1/B	BACKBAR (ONLY) w/BLACK FINISH FOR MXT-1 QUAD TOM CARRIER	93.00

PEARL MARCHING STANDS

MSS-3000	MARCHING SNARE STAND - ADJUSTABLE LEGS FOR BLEACHERS OR LEVEL SURFACES	\$282.00
MTS-3000	MARCHING TOM STAND - ADJUSTABLE LEGS FOR BLEACHERS OR LEVEL SURFACES	316.00
MBS-3000	MARCHING BASS STAND - ADJUSTABLE LEGS FOR BLEACHERS OR LEVEL SURFACES	310.50

MARCHING CASES, COVERS & REPLACEMENT STRAPS

CASES - ROTATIONALLY MOLDED

PD-1412	13"x14" SNARE DRUMS	\$147.50
PD-8004	QUAD/QUINT/SEXTET	283.50
PD-1414	14"x14" BASS DRUM	147.50
PD-1614	16"x14" BASS DRUM	159.00
PD-1814	18"x14" BASS DRUM	164.50
PD-2014	20"x14" BASS DRUM	181.50
PD-2214	22"x14" BASS DRUM	204.50
PD-2414	24"x14" BASS DRUM	221.50
PD-2614	26"x14" BASS DRUM	238.50
PD-2814	28"x14" BASS DRUM	250.00
PD-3016	30"x16" BASS DRUM	255.50
PD-3216	32"x16" BASS DRUM	261.00

* LIMITED LIFETIME WARRANTY * NO FOAM

COVERS - GREY

MDCG-13	13" SNARE	\$63.50
MDCG-14	14" SNARE	63.50
MDCG-8023	QUAD FITS 8023 & 8024	88.00
MDCG-0234	QUAD FITS 0234	88.00
MDCG-14B	14" BASS DRUM	63.50
MDCG-16	16" BASS DRUM	69.00
MDCG-18	18" BASS DRUM	69.00
MDCG-20	20" BASS DRUM	77.00
MDCG-22	22" BASS DRUM	77.00
MDCG-24	24" BASS DRUM	82.50
MDCG-26	26" BASS DRUM	88.00
MDCG-28	28" BASS DRUM	88.00
MDCG-30	30" BASS DRUM	93.50
MDCG-32	32" BASS DRUM	93.50

STRAPS

PDS-60	60" w/CLIP FOR PDCH	\$15.50
PDS-74	74" w/CLIP FOR PD1412	15.50
PDS-82	82" w/CLIP FOR PD-1414/1614/1814	16.00
PDS-88	88" w/CLIP FOR PD-2014/PD8004	16.00
PDS-97	97" w/CLIP FOR PD-2214	16.00
PDS-101	101" w/CLIP FOR PD-2414	17.00
PDS-103	103" w/CLIP FOR PD-2614	17.00
PDS-105	105" w/CLIP FOR PD-2814	17.00
PDS-115	115" w/CLIP FOR PD-3016/3216	18.00

MARCHING ACCESSORIES

DRUM KEYS

K-030	HIGH TENSION TUNING KEY	\$12.00
KGT-100H	GYROTUNE KEY w/QUICK-RELEASE NECK STRAP	23.00
K-080	STANDARD KEY	7.00
K-180	SPIN-TIGHT KEY	30.00

MULTI-USE HOLDERS

MUH-10	CYMBAL HOLDER CLAMPS TO FFX EDGE RING	\$43.00
MUH-20	3/8 PERC. ROD CLAMPS TO FFX TENSION POSTS	43.00
MUH-10T	CYMBAL HOLDER CLAMPS TO SUPERHOOP II	43.00
PCS-11	MARCHING BASS DRUM ACCESSORY MOUNT	51.50

STICK & Mallet BAGS

MSB-1	HOLDS 1PR. STICKS - ATTACHES w/VELCRO STRAPS	\$29.50
MSB-2	HOLDS 2PR. STICKS - ATTACHES w/VELCRO STRAPS	39.50
MMB-1	FOR MALLETS - ATTACHES w/VELCRO STRAPS	35.95

QUICK-MOUNT LALO REHEARSAL PAD

PAD-35LA	3.5" RUBBER PRACTICE PAD - ATTACHES TO 3/8" RODS VIA THE INCLUDED CLAMP FOR ON-FIELD OR PRACTICE ROOM WARMUP, ETC.	\$34.50
-----------------	---	----------------

SOUND PROJECTORS FOR SNARE DRUMS

SP-1	14" WHITE w/PEARL LOGO	\$44.30
SP-2	13" WHITE w/PEARL LOGO	41.50
SP-1B	14" BLACK w/PEARL LOGO	44.30
SP-2B	13" BLACK w/PEARL LOGO	41.50

SLING ACCESSORIES FOR SNARE DRUMS

LR-40	LEG REST	\$56.50
NEW LR-60	FFX LEG REST ATTACHES TO TENSION POST	56.50
SLG-100	SLING w/THREE CONFIGURATIONS	41.00
CH-5S	CARRY HOOK ATTACHES TO EDGE RING	13.50
MH-30	LEVEL BAR FOR SLING-CARRIED 10 LUG SNARE DRUMS	7.50
NEW MH-50	FFX LEVEL BAR FOR SLING-CARRIED 12 LUG SNARE DRUMS	25.00

MALLET HOLDERS FOR BASS DRUMS

BMH-1	MALLET HOLDER w/TAPE - SET OF 7	\$18.00
BMH-100	MALLET HOLDER REMOVABLE w/BUILT-IN RIMSHOOTERS	84.00
NP-439/4	REPLACEMENT CLIPS FOR BMH-100 - PACK OF 4	10.50

TONE STRIPS FOR BASS DRUMS

TS-14	2 x EIGHT FOOT ROLLS	\$22.50
--------------	----------------------------	----------------

RIM SHOOTER FOR BASS DRUMS

BDR-1	CLAMP-ON HOOP PROTECTOR	\$26.00
--------------	-------------------------------	----------------

CHAMPIONSHIP CARBONPLY SERIES



SHELLS: SNARES & TENORS: CARBON FIBER OVER 6 PLY AFRICAN MAHOGANY
 BASS DRUMS: CARBON FIBER OVER 6 PLY MAPLE

STANDARD LACQUER FINISH: #301 CARBON FIBER MATTE *SPECIAL ORDER FINISHES - PLEASE ALLOW 3 TO 5 MONTHS FOR DELIVERY

SPECIAL ORDER POWDER COATING: • BLACK • WHITE • BLUE • YELLOW • RED • GREEN • ORANGE • PURPLE PLEASE ALLOW 6-8 WEEKS FOR DELIVERY (IF DRUMS ARE IN STOCK).

SNARE DRUMS	POLISHED ALUMINUM	POWDER COATED	CHROME PLATED
FFXC-1412/A* 14"x12" (16.09 LBS)	\$1,342.00	\$1,932.00	\$1,673.00
FFXC-1311/A* 13"x11" (14.55 LBS)	1,223.00	1,773.00	1,555.00

HEADS: CC BATTER / ST SNARE
 HARDWARE: POLISHED ALUMINUM
 *SPECIAL ORDER

BASS DRUMS	STANDARD ALUMINUM	POWDER COATED	CHROME PLATED
PBDC-1414/A* 14"x14"	\$1,151.00	\$1,572.50	\$1,238.00
PBDC-1614/A* 16"x14" (15.43 LBS)	1,167.00	1,588.00	1,254.00
PBDC-1814/A* 18"x14" (17.19 LBS)	1,291.00	1,709.00	1,377.00
PBDC-2014/A* 20"x14" (19.18 LBS)	1,398.00	1,822.00	1,510.00
PBDC-2214/A* 22"x14" (21.16 LBS)	1,456.00	1,902.00	1,568.00
PBDC-2414/A* 24"x14" (22.48 LBS)	1,574.00	1,983.00	1,687.00
PBDC-2614/A* 26"x14" (24.03 LBS)	1,634.00	2,075.50	1,746.00
PBDC-2814/A* 28"x14" (27.55 LBS)	1,792.00	2,217.50	1,904.00
 PBDC-3016/A* 30"x16" (33.06 LBS)	2,121.00	2,531.00	2,254.00
 PBDC-3216/A* 32"x16" (33.29 LBS)	2,258.00	2,685.50	2,390.00

*SPECIAL ORDER
 HEADS: SMOOTH WHITE AMBASSADORS

SONIC-CUT TENORS	STANDARD ALUMINUM	POWDER COATED	CHROME PLATED
PMTC-8023N/A* QUAD 8,10,12,13	\$2,199.00	\$2,714.50	\$2,377.00
PMTC-0234N/A* QUAD 10,12,13,14	2,587.00	3,175.00	2,786.00
PMTC-68023N/A* QUINT 6,8,10,12,13	2,697.00	3,330.50	2,921.00
PMTC-60234N/A* QUINT 6,10,12,13,14	3,085.00	3,791.00	3,330.00
PMTC-668023N/A* SEXTET 6,6,8,10,12,13	3,195.00	3,946.50	3,465.00
PMTC-660234N/A* SEXTET 6,6,10,12,13,14	3,583.00	4,407.00	3,874.00
PMTC-680234N/A* SEXTET 6,8,10,12,13,14	3,597.00	4,419.50	3,863.00
PTC68P/A* 6"x8" & 8"x8" SET W/MTG BRKTS ...	1,010.00	1,244.50	1,077.00
PTC-0608N/A* 6"x8" TOM	491.00	609.00	537.00
PTC-0808/A* 8"x8" TOM	521.00	639.00	567.00
PTC-1010/A* 10"x10" TOM	602.00	721.00	648.00
PTC-1212/A* 12"x12" TOM	779.00	903.00	845.00
PTC-1312/A* 13"x12" TOM	796.00	918.00	862.00
PTC-1413/A* 14"x13" TOM	932.00	1,059.00	998.00

HEADS: CT BATTER
 *SPECIAL ORDER

CHAMPIONSHIP MAPLE CARBONCORE SERIES

SHELLS: • SNARES & TENORS: 6 PLY MAPLE w/INNER PLY CARBON FIBER

STANDARD LACQUER FINISH: • #368 BLACK SILVER BURST

SPECIAL ORDER COVERED & LACQUER FINISHES: PLEASE SEE PAGE 46 IN THIS PRICE LIST *SPECIAL ORDERS - PLEASE ALLOW 3 TO 5 MONTHS FOR DELIVERY

SPECIAL ORDER POWDER COATING: • BLACK • WHITE • BLUE • YELLOW • RED • GREEN • ORANGE • PURPLE PLEASE ALLOW 6-8 WEEKS FOR DELIVERY (IF DRUMS ARE IN STOCK).

SNARE DRUMS	POLISHED ALUMINUM	POWDER COATED	CHROME PLATED
FFXIC1412/A 14"x12" (16.09 LBS)	\$1,288.00	\$1,854.00	\$1,619.00
FFXIC1410/A 14"x10" (16.09 LBS)	1,288.00	1,854.00	1,619.00
FFXIC1311/A 13"x11" (14.55 LBS)	1,176.00	1,705.00	1,507.00

HARDWARE: POLISHED ALUMINUM
 HEADS: CC BATTER / ST SNARE

BASS DRUMS

WE RECOMMEND 100% MAPLE CHAMPIONSHIP LACQUER BASS DRUMS WITH CARBONCORE SNARES AND TENORS. PLEASE REFER TO PAGE 32.

SONIC-CUT TENORS	STANDARD ALUMINUM	POWDER COATED	CHROME PLATED
PTIC8023N/A QUAD 8,10,12,13	\$2,049.00	\$2,529.50	\$2,227.00
PTIC0234N/A QUAD 10,12,13,14	2,411.00	2,959.00	2,610.00
PTIC68023N/A QUINT 6,8,10,12,13	2,513.00	3,103.50	2,737.00
PTIC60234N/A QUINT 6,10,12,13,14	2,875.00	3,533.00	3,120.00
PTIC668023N/A SEXTET 6,6,8,10,12,13	2,977.00	3,677.50	3,247.00
PTIC660234N/A SEXTET 6,6,10,12,13,14	3,339.00	4,107.00	3,630.00
PTIC680234N/A SEXTET 6,8,10,12,13,14	3,353.00	4,119.50	3,618.00
PTIC68P/A 6"x8" & 8"x8" SET W/MTG BRKTS ...	942.00	1,160.50	1,007.00
PTIC0608N/A 6"x8" TOM	457.00	567.00	503.00
PTIC0808/A 8"x8" TOM	485.00	595.00	531.00
PTIC1010/A 10"x10" TOM	561.00	672.00	607.00
PTIC1212/A 12"x12" TOM	726.00	841.00	792.00
PTIC1312/A 13"x12" TOM	742.00	856.00	808.00
PTIC1413/A 14"x13" TOM	869.00	987.00	935.00

HEADS: CT BATTER

SHALLOW-CUT TENORS	STANDARD ALUMINUM	POWDER COATED	CHROME PLATED
PSIC8023N/A QUAD 8,10,12,13	\$2,049.00	\$2,529.50	\$2,227.00
PSIC0234N/A QUAD 10,12,13,14	2,411.00	2,959.00	2,610.00
PSIC68023N/A QUINT 6,8,10,12,13	2,513.00	3,103.50	2,737.00
PSIC60234N/A QUINT 6,10,12,13,14	2,875.00	3,533.00	3,120.00
PSIC668023N/A SEXTET 6,6,8,10,12,13	2,977.00	3,677.50	3,247.00
PSIC660234N/A SEXTET 6,6,10,12,13,14	3,339.00	4,107.00	3,630.00
PSIC680234N/A SEXTET 6,8,10,12,13,14	3,353.00	4,119.50	3,618.00
PTIC0808/A 8"x8" TOM - SPECIAL ORDER	485.00	595.00	531.00
PSIC1009/A 10"x9" TOM - SPECIAL ORDER	561.00	672.00	607.00
PSIC1210/A 12"x10" TOM - SPECIAL ORDER	726.00	841.00	792.00
PSIC1310/A 13"x10" TOM - SPECIAL ORDER	742.00	856.00	808.00
PSIC1411/A 14"x11" TOM - SPECIAL ORDER	869.00	987.00	935.00

HEADS: CT BATTER

NEW

CHAMPIONSHIP CARBONCORE SERIES

NEW ONE-TOUCH STRAINER

NEW WEIGHT REDUCTION - 2 LBS+

SHELLS: • SNARES & TENORS: 6 PLY MAPLE w/INNER PLY CARBON FIBER

STANDARD LACQUER FINISH: • #368 BLACK SILVER BURST

NEW SPECIAL ORDER COVERED, LACQUER & "VARSITY" FINISHES: PLEASE SEE PAGE 46 IN THIS PRICE LIST. NOTE: "400" COVERED FINISHES ARE SUBJECT TO LACQUER PRICING. *SPECIAL ORDERS - PLEASE ALLOW 3 TO 5 MONTHS FOR DELIVERY

SPECIAL ORDER POWDER COATING: • BLACK • WHITE • BLUE • YELLOW • RED • GREEN • ORANGE • PURPLE PLEASE ALLOW 6-8 WEEKS FOR DELIVERY (IF DRUMS ARE IN STOCK).

SNARE DRUMS

	POLISHED ALUMINUM	POWDER COATED	CHROME PLATED
FFXCC-1412/A 14"x12" (2+LBS REDUCTION) w/ONE TOUCH STRAINER	\$1,352.00	TBD	TBD
FFXCC-1311/A 13"x11" (2+LBS REDUCTION) w/ONE TOUCH STRAINER	1,176.00	TBD	TBD

HARDWARE: POLISHED ALUMINUM
HEADS: CC BATTER / ST SNARE

BASS DRUMS

WE RECOMMEND 100% MAPLE CHAMPIONSHIP LACQUER BASS DRUMS WITH CARBONCORE SNARES AND TENORS. PLEASE REFER TO PAGE 33.

SONIC-CUT TENORS

	STANDARD ALUMINUM	POWDER COATED	CHROME PLATED
PMTCC-8023/A QUAD 8,10,12,13	\$2,151.50	TBD	TBD
PMTCC-0234/A QUAD 10,12,13,14	2,532.00		
PMTCC-68023/A QUINT 6,8,10,12,13	2,655.00		
PMTCC-60234/A QUINT 6,10,12,13,14	3,035.50		
PMTCC-668023/A SEXTET 6,6,8,10,12,13	3,158.50		
PMTCC-660234/A SEXTET 6,6,10,12,13,14	3,539.00		
PMTCC-680234/A SEXTET 6,8,10,12,13,14	3,521.50		
PMTCC-68/A 6"x8" & 8"x8" SET w/MTG BRKTS ...	989.50		
PMTCC-0608/A 6"x8" TOM	480.00		
PMTCC-0808/A 8"x8" TOM	509.50		
PMTCC-1010/A 10"x10" TOM	589.50		
PMTCC-1212/A 12"x12" TOM	762.50		
PMTCC-1312/A 13"x12" TOM	779.50		
PMTCC-1413/A 14"x13" TOM	912.50		

HEADS: CT BATTER

SHALLOW-CUT TENORS

	STANDARD ALUMINUM	POWDER COATED	CHROME PLATED
PMTCCS-8023/A QUAD 8,10,12,13	\$2,151.50	TBD	TBD
PMTCCS-0234/A QUAD 10,12,13,14	2,532.00		
PMTCCS-68023/A QUINT 6,8,10,12,13	2,655.00		
PMTCCS-60234/A QUINT 6,10,12,13,14	3,035.50		
PMTCCS-668023/A SEXTET 6,6,8,10,12,13	3,158.50		
PMTCCS-660234/A SEXTET 6,6,10,12,13,14	3,539.00		
PMTCCS-680234/A SEXTET 6,8,10,12,13,14	3,521.50		
PMTCC-68/A 6"x8" & 8"x8" SET w/MTG BRKTS ...	989.50		
PMTCC-0608/A 6"x8" TOM	480.00		
PMTCC-0808/A 8"x8" TOM - SPECIAL ORDER	509.50		
PMTCCS-1009/A 10"x9" TOM - SPECIAL ORDER	589.50		
PMTCCS-1210/A 12"x10" TOM - SPECIAL ORDER	762.50		
PMTCCS-1310/A 13"x10" TOM - SPECIAL ORDER	779.50		
PMTCCS-1411/A 14"x11" TOM - SPECIAL ORDER	912.50		

HEADS: CT BATTER

CHAMPIONSHIP MAPLE SERIES

FFX SNARE DRUMS

SHELLS: 6 PLY 100% MAPLE

POLISHED ALUMINUM FFX HARDWARE

HEADS: CC BATTER & ST SNARE

STANDARD COVERED FINISHES: • #26 BRUSHED SILVER • #33 PURE WHITE • #46 MIDNIGHT BLACK

SPECIAL ORDER COVERED & LACQUER FINISHES: PLEASE SEE PAGE 46 IN THIS PRICE LIST. NOTE: "400" COVERED FINISHES ARE SUBJECT TO LACQUER PRICING. *SPECIAL ORDERS - PLEASE ALLOW 3 TO 5 MONTHS FOR DELIVERY

SPECIAL ORDER POWDER COATING: • BLACK • WHITE • BLUE • YELLOW • RED • GREEN • ORANGE • PURPLE PLEASE ALLOW 6-8 WEEKS FOR DELIVERY (IF DRUMS ARE IN STOCK).

COVERED - IN STOCK			POLISHED ALUMINUM	POWDER COATED	CHROME PLATED	LACQUER - *SPECIAL ORDER			POLISHED ALUMINUM	POWDER COATED	CHROME PLATED
BEST SELLER	FFX-1412/A	14"x12" (16.9 LBS)	\$1,092.50	\$1,552.50	\$1,447.00	FFXL-1412/A*	14"x12" (16.9 LBS)	\$1,255.00	\$1,769.00	\$1,587.00	
	FFX-1410/A*	14"x10" (16.9 LBS)	1,092.50	1,552.50	1,447.00	FFXL-1410/A*	14"x10" (16.9 LBS)	1,255.00	1,769.00	1,587.00	
BEST SELLER	FFX-1311/A	13"x11" (14 LBS)	960.00	1,438.50	1,312.50	FFXL-1311/A*	13"x11" (14 LBS)	1,120.00	1,624.50	1,452.00	

COVERED FFX SNARE DRUM / PEARL CARRIER / STAND / CASE PACKAGES

FFX -1412/A PACKAGES	FFX-1412/A DRUM	CXS-1 CARRIER	MSS-3000 STAND	PD-1412 CASE	POLISHED ALUMINUM
FFX-1412/ACN	X	-	-	X	\$1,240.00
FFX-1412/AXN	X	X	-	-	1,532.50
FFX-1412/AXCN	X	X	-	X	1,680.00
FFX-1412/AXSN	X	X	X	-	1,814.50
FFX-1412/AXCSN	X	X	X	X	1,962.00
FFX -1410/A PACKAGES	FFX-1410/A DRUM	CXS-1 CARRIER	MSS-3000 STAND	PD-1412 CASE	POLISHED ALUMINUM
FFX-1410/ACN	X	-	-	X	\$1,240.00
FFX-1410/AXN	X	X	-	-	1,532.50
FFX-1410/AXCN	X	X	-	X	1,680.00
FFX-1410/AXSN	X	X	X	-	1,814.50
FFX-1410/AXCSN	X	X	X	X	1,962.00
FFX -1311/A PACKAGES	FFX-1311/A DRUM	CXS-1 CARRIER	MSS-3000 STAND	PD-1412 CASE	POLISHED ALUMINUM
FFX-1311/ACN	X	-	-	X	\$1,107.50
FFX-1311/AXN	X	X	-	-	1,400.00
FFX-1311/AXCN	X	X	-	X	1,547.50
FFX-1311/AXSN	X	X	X	-	1,682.00
FFX-1311/AXCSN	X	X	X	X	1,829.50

NEW

CHAMPIONSHIP MAPLE SERIES

FFX SNARE DRUMS

NEW ONE-TOUCH STRAINER

NEW WEIGHT REDUCTION - 2LBS+

SHELLS: 6 PLY 100% MAPLE

POLISHED ALUMINUM FFX HARDWARE

HEADS: CC BATTER & ST SNARE

STANDARD COVERED FINISHES: • #33 PURE WHITE • #46 MIDNIGHT BLACK

NEW STANDARD LACQUER FINISH: • #360 SILVER SPARKLE

NEW SPECIAL ORDER COVERED, LACQUER & "VARSITY" FINISHES: PLEASE SEE PAGE 46 IN THIS PRICE LIST. NOTE: "400" COVERED FINISHES ARE SUBJECT TO LACQUER PRICING. *SPECIAL ORDERS - PLEASE ALLOW 3 TO 5 MONTHS FOR DELIVERY

SPECIAL ORDER POWDER COATING: • BLACK • WHITE • BLUE • YELLOW • RED • GREEN • ORANGE • PURPLE PLEASE ALLOW 6-8 WEEKS FOR DELIVERY (IF DRUMS ARE IN STOCK).

COVERED		POLISHED ALUMINUM	POWDER COATED	CHROME PLATED	LACQUER		POLISHED ALUMINUM	POWDER COATED	CHROME PLATED	
BEST SELLER	FFXM-1412/A	14"x12" (14.5 LBS)	\$1,147.50	TBD	TBD	FFXML-1412/A	14"x12" (14.5 LBS)	\$1,318.00	TBD	TBD
BEST SELLER	FFXM-1311/A	13"x11" (11.5 LBS)	1,008.00			FFXML-1311/A	13"x11" (11.5 LBS)	1,176.00		

COVERED FFX SNARE DRUM / PEARL CARRIER / STAND / CASE PACKAGES

FFXM -1412/A PACKAGES	FFXM-1412/A DRUM	CXS-1 CARRIER	MSS-3000 STAND	PD-1412 CASE	POLISHED ALUMINUM
FFXM-1412/AC	X	-	-	X	TBD
FFXM-1412/AX	X	X	-	-	
FFXM-1412/AXC	X	X	-	X	
FFXM-1412/AXS	X	X	X	-	
FFXM-1412/AXCS	X	X	X	X	
FFXM -1311/A PACKAGES	FFXM-1311/A DRUM	CXS-1 CARRIER	MSS-3000 STAND	PD-1412 CASE	POLISHED ALUMINUM
FFXM-1311/AC	X	-	-	X	TBD
FFXM-1311/AX	X	X	-	-	
FFXM-1311/AXC	X	X	-	X	
FFXM-1311/AXS	X	X	X	-	
FFXM-1311/AXCS	X	X	X	X	

CHAMPIONSHIP MAPLE SERIES

BASS DRUMS

SHELLS: 6 PLY 100% MAPLE

HEADS: REMO SMOOTH WHITE AMBASSADORS

STANDARD COVERED FINISHES: • #26 BRUSHED SILVER • #33 PURE WHITE • #46 MIDNIGHT BLACK

SPECIAL ORDER COVERED & LACQUER FINISHES: PLEASE SEE PAGE 46 IN THIS PRICE LIST. NOTE: "400" COVERED FINISHES ARE SUBJECT TO LACQUER PRICING. *SPECIAL ORDERS - PLEASE ALLOW 3 TO 5 MONTHS FOR DELIVERY

SPECIAL ORDER POWDER COATING: • BLACK • WHITE • BLUE • YELLOW • RED • GREEN • ORANGE • PURPLE PLEASE ALLOW 6-8 WEEKS FOR DELIVERY (IF DRUMS ARE IN STOCK).

	COVERED - IN STOCK	STANDARD ALUMINUM	POWDER COATED	CHROME PLATED
BEST SELLER	PBD-1414 14"x14" (13 LBS)	\$812.00	\$1,205.50	\$921.00
BEST SELLER	PBD-1614 16"x14" (14.6 LBS)	846.00	1,235.50	955.50
BEST SELLER	PBD-1814 18"x14" (16.4 LBS)	957.50	1,359.00	1,070.00
BEST SELLER	PBD-2014 20"x14" (19 LBS)	1,030.50	1,434.00	1,171.00
BEST SELLER	PBD-2214 22"x14" (20.1 LBS)	1,064.00	1,459.50	1,205.50
BEST SELLER	PBD-2414 24"x14" (21.5 LBS)	1,099.00	1,485.50	1,241.50
	PBD-2614 26"x14" (22.8 LBS)	1,219.00	1,626.50	1,364.00
	PBD-2814 28"x14" (24.3 LBS)	1,253.00	1,653.50	1,399.00
	PBD-3016 30"x16" (29 LBS)	1,476.00	1,802.50	1,648.50
	PBD-3216 32"x16" (29.4 LBS)	1,558.00	1,963.50	1,732.50

	LACQUER - *SPECIAL ORDER	STANDARD ALUMINUM	POWDER COATED	CHROME PLATED
	PBDL-1414* 14"x14" (13 LBS)	\$1,065.00	\$1,459.00	\$1,152.00
	PBDL-1614* 16"x14" (14.6 LBS)	1,082.00	1,457.00	1,168.00
	PBDL-1814* 18"x14" (16.4 LBS)	1,154.00	1,574.50	1,241.00
	PBDL-2014* 20"x14" (19 LBS)	1,232.00	1,660.00	1,344.00
	PBDL-2214* 22"x14" (20.1 LBS)	1,260.00	1,651.00	1,372.00
	PBDL-2414* 24"x14" (21.5 LBS)	1,355.00	1,746.50	1,467.00
	PBDL-2614* 26"x14" (22.8 LBS)	1,444.00	1,931.00	1,556.00
	PBDL-2814* 28"x14" (24.3 LBS)	1,521.00	2,023.50	1,634.00
	PBDL-3016* 30"x16" (29 LBS)	1,867.00	2,229.00	2,000.00
	PBDL-3216* 32"x16" (29.4 LBS)	1,978.00	2,342.00	2,111.00

COVERED BASS DRUM / PEARL CARRIER / STAND / CASE PACKAGES

PBD-1414 PACKAGES	PBD-1414 DRUM	CXB-1 CARRIER	MBS-3000 STAND	PD-1414 CASE	STANDARD ALUMINUM
PBD1414CN	X	-	-	X	\$959.50
PBD1414XN	X	X	-	-	1,252.00
PBD1414XCN	X	X	-	X	1,399.50
PBD1414XSN	X	X	X	-	1,562.50
PBD1414XCSN	X	X	X	X	1,710.00

PBD-1614 PACKAGES	PBD-1614 DRUM	CXB-1 CARRIER	MBS-3000 STAND	PD-1614 CASE	STANDARD ALUMINUM
PBD1614CN	X	-	-	X	\$1,005.00
PBD1614XN	X	X	-	-	1,286.00
PBD1614XCN	X	X	-	X	1,445.00
PBD1614XSN	X	X	X	-	1,596.50
PBD1614XCSN	X	X	X	X	1,755.50

PBD-1814 PACKAGES	PBD-1814 DRUM	CXB-1 CARRIER	MBS-3000 STAND	PD-1814 CASE	STANDARD ALUMINUM
PBD1814CN	X	-	-	X	\$1,122.00
PBD1814XN	X	X	-	-	1,397.50
PBD1814XCN	X	X	-	X	1,562.00
PBD1814XSN	X	X	X	-	1,708.00
PBD1814XCSN	X	X	X	X	1,872.50

PBD-2014 PACKAGES	PBD-2014 DRUM	CXB-1 CARRIER	MBS-3000 STAND	PD-2014 CASE	STANDARD ALUMINUM
PBD2014CN	X	-	-	X	\$1,212.00
PBD2014XN	X	X	-	-	1,470.50
PBD2014XCN	X	X	-	X	1,652.00
PBD2014XSN	X	X	X	-	1,781.00
PBD2014XCSN	X	X	X	X	1,962.50

PBD-2214 PACKAGES	PBD-2214 DRUM	CXB-1 CARRIER	MBS-3000 STAND	PD-2214 CASE	STANDARD ALUMINUM
PBD2214CN	X	-	-	X	\$1,268.50
PBD2214XN	X	X	-	-	1,504.00
PBD2214XCN	X	X	-	X	1,708.50
PBD2214XSN	X	X	X	-	1,814.50
PBD2214XCSN	X	X	X	X	2,019.00

PBD-2414 PACKAGES	PBD-2414 DRUM	CXB-1 CARRIER	MBS-3000 STAND	PD-2414 CASE	STANDARD ALUMINUM
PBD2414CN	X	-	-	X	\$1,320.50
PBD2414XN	X	X	-	-	1,539.00
PBD2414XCN	X	X	-	X	1,760.50
PBD2414XSN	X	X	X	-	1,849.50
PBD2414XCSN	X	X	X	X	2,071.00

PBD-2614 PACKAGES	PBD-2614 DRUM	CXB-1 CARRIER	MBS-3000 STAND	PD-2614 CASE	STANDARD ALUMINUM
PBD2614CN	X	-	-	X	\$1,457.50
PBD2614XN	X	X	-	-	1,659.00
PBD2614XCN	X	X	-	X	1,897.50
PBD2614XSN	X	X	X	-	1,969.50
PBD2614XCSN	X	X	X	X	2,208.00

PBD-2814 PACKAGES	PBD-2814 DRUM	CXB-1 CARRIER	MBS-3000 STAND	PD-2814 CASE	STANDARD ALUMINUM
PBD2814CN	X	-	-	X	\$1,503.00
PBD2814XN	X	X	-	-	1,693.00
PBD2814XCN	X	X	-	X	1,943.00
PBD2814XSN	X	X	X	-	2,003.50
PBD2814XCSN	X	X	X	X	2,253.50

PBD-3016 PACKAGES	PBD-3016 DRUM	CXB-1 CARRIER	MBS-3000 STAND	PD-3016 CASE	STANDARD ALUMINUM
PBD3016CN	X	-	-	X	\$1,731.50
PBD3016XN	X	X	-	-	1,916.00
PBD3016XCN	X	X	-	X	2,171.50
PBD3016XSN	X	X	X	-	2,226.50
PBD3016XCSN	X	X	X	X	2,482.00

PBD-3216 PACKAGES	PBD-3216 DRUM	CXB-1 CARRIER	MBS-3000 STAND	PD-3216 CASE	STANDARD ALUMINUM
PBD-3216CN	X	-	-	X	\$1,819.00
PBD-3216XN	X	X	-	-	1,998.00
PBD-3216XCN	X	X	-	X	2,259.00
PBD-3216XSN	X	X	X	-	2,308.50
PBD-3216XCSN	X	X	X	X	2,569.50

NEW

CHAMPIONSHIP MAPLE SERIES

BASS DRUMS

SHELLS: 6 PLY 100% MAPLE



HEADS: REMO SMOOTH WHITE AMBASSADORS



STANDARD COVERED FINISHES: • #33 PURE WHITE • #46 MIDNIGHT BLACK

NEW STANDARD LACQUER FINISH: • #360 SILVER SPARKLE

NEW SPECIAL ORDER COVERED, LACQUER & "VARSITY" FINISHES: PLEASE SEE PAGE 46 IN THIS PRICE LIST. NOTE: "400" COVERED FINISHES ARE SUBJECT TO LACQUER PRICING. *SPECIAL ORDERS - PLEASE ALLOW 3 TO 5 MONTHS FOR DELIVERY

SPECIAL ORDER POWDER COATING: • BLACK • WHITE • BLUE • YELLOW • RED • GREEN • ORANGE • PURPLE PLEASE ALLOW 6-8 WEEKS FOR DELIVERY (IF DRUMS ARE IN STOCK).

	COVERED	STANDARD ALUMINUM	POWDER COATED	CHROME PLATED
<small>BEST SELLER</small>	PBDM-1414/A 14"x14" (13 LBS)	\$853.00	TBD	TBD
<small>BEST SELLER</small>	PBDM-1614/A 16"x14" (14.6 LBS)	888.50		
<small>BEST SELLER</small>	PBDM-1814/A 18"x14" (16.4 LBS)	1,005.50		
<small>BEST SELLER</small>	PBDM-2014/A 20"x14" (19 LBS)	1,082.50		
<small>BEST SELLER</small>	PBDM-2214/A 22"x14" (20.1 LBS)	1,117.50		
<small>BEST SELLER</small>	PBDM-2414/A 24"x14" (21.5 LBS)	1,154.00		
	PBDM-2614/A 26"x14" (22.8 LBS)	1,280.00		
	PBDM-2814/A 28"x14" (24.3 LBS)	1,316.00		
	PBDM-3016/A 30"x16" (29 LBS)	1,550.00		
	PBDM-3216/A 32"x16" (29.4 LBS)	1,636.00		

	LACQUER	STANDARD ALUMINUM	POWDER COATED	CHROME PLATED
	PBDML-1414/A 14"x14" (13 LBS)	\$1,118.50	TBD	\$TBD
	PBDML-1614/A 16"x14" (14.6 LBS)	1,136.50		
	PBDML-1814/A 18"x14" (16.4 LBS)	1,212.00		
	PBDML-2014/A 20"x14" (19 LBS)	1,294.00		
	PBDML-2214/A 22"x14" (20.1 LBS)	1,323.00		
	PBDML-2414/A 24"x14" (21.5 LBS)	1,423.00		
	PBDML-2614/A 26"x14" (22.8 LBS)	1,516.50		
	PBDML-2814/A 28"x14" (24.3 LBS)	1,597.50		
	PBDML-3016/A 30"x16" (29 LBS)	1,960.50		
	PBDML-3216/A 32"x16" (29.4 LBS)	2,077.00		

COVERED BASS DRUM / PEARL CARRIER / STAND / CASE PACKAGES

PBDM-1414/A PACKAGES	PBDM-1414/A DRUM	CXB-1 CARRIER	MBS-3000 STAND	PD-1414 CASE	STANDARD ALUMINUM
PBDM-1414/AC	X	-	-	X	TBD
PBDM-1414/AX	X	X	-	-	
PBDM-1414/AXC	X	X	-	X	
PBDM-1414/AXS	X	X	X	-	
PBDM-1414/AXCS	X	X	X	X	

PBDM-1614/A PACKAGES	PBDM-1614/A DRUM	CXB-1 CARRIER	MBS-3000 STAND	PD-1614 CASE	STANDARD ALUMINUM
PBDM-1614/AC	X	-	-	X	TBD
PBDM-1614/AX	X	X	-	-	
PBDM-1614/AXC	X	X	-	X	
PBDM-1614/AXS	X	X	X	-	
PBDM-1614/AXCS	X	X	X	X	

PBDM-1814/A PACKAGES	PBDM-1814/A DRUM	CXB-1 CARRIER	MBS-3000 STAND	PD-1814 CASE	STANDARD ALUMINUM
PBDM-1814/AC	X	-	-	X	TBD
PBDM-1814/AX	X	X	-	-	
PBDM-1814/AXC	X	X	-	X	
PBDM-1814/AXS	X	X	X	-	
PBDM-1814/AXCS	X	X	X	X	

PBDM-2014/A PACKAGES	PBDM-2014/A DRUM	CXB-1 CARRIER	MBS-3000 STAND	PD-2014 CASE	STANDARD ALUMINUM
PBDM-2014/AC	X	-	-	X	TBD
PBDM-2014/AX	X	X	-	-	
PBDM-2014/AXC	X	X	-	X	
PBDM-2014/AXS	X	X	X	-	
PBDM-2014/AXCS	X	X	X	X	

PBDM-2214/A PACKAGES	PBDM-2214/A DRUM	CXB-1 CARRIER	MBS-3000 STAND	PD-2214 CASE	STANDARD ALUMINUM
PBDM-2214/AC	X	-	-	X	TBD
PBDM-2214/AX	X	X	-	-	
PBDM-2214/AXC	X	X	-	X	
PBDM-2214/AXS	X	X	X	-	
PBDM-2214/AXCS	X	X	X	X	

PBDM-2414/A PACKAGES	PBDM-2414/A DRUM	CXB-1 CARRIER	MBS-3000 STAND	PD-2414 CASE	STANDARD ALUMINUM
PBDM-2414/AC	X	-	-	X	TBD
PBDM-2414/AX	X	X	-	-	
PBDM-2414/AXC	X	X	-	X	
PBDM-2414/AXS	X	X	X	-	
PBDM-2414/AXCS	X	X	X	X	

PBDM-2614/A PACKAGES	PBDM-2614/A DRUM	CXB-1 CARRIER	MBS-3000 STAND	PD-2614 CASE	STANDARD ALUMINUM
PBDM-2614/AC	X	-	-	X	TBD
PBDM-2614/AX	X	X	-	-	
PBDM-2614/AXC	X	X	-	X	
PBDM-2614/AXS	X	X	X	-	
PBDM-2614/AXCS	X	X	X	X	

PBDM-2814/A PACKAGES	PBDM-2814/A DRUM	CXB-1 CARRIER	MBS-3000 STAND	PD-2814 CASE	STANDARD ALUMINUM
PBDM-2814/AC	X	-	-	X	TBD
PBDM-2814/AX	X	X	-	-	
PBDM-2814/AXC	X	X	-	X	
PBDM-2814/AXS	X	X	X	-	
PBDM-2814/AXCS	X	X	X	X	

PBDM-3016/A PACKAGES	PBDM-3016/A DRUM	CXB-1 CARRIER	MBS-3000 STAND	PD-3016 CASE	STANDARD ALUMINUM
PBDM-3016/AC	X	-	-	X	TBD
PBDM-3016/AX	X	X	-	-	
PBDM-3016/AXC	X	X	-	X	
PBDM-3016/AXS	X	X	X	-	
PBDM-3016/AXCS	X	X	X	X	

PBDM-3216/A PACKAGES	PBDM-3216/A DRUM	CXB-1 CARRIER	MBS-3000 STAND	PD-3216 CASE	STANDARD ALUMINUM
PBDM-3216/AC	X	-	-	X	TBD
PBDM-3216/AX	X	X	-	-	
PBDM-3216/AXC	X	X	-	X	
PBDM-3216/AXS	X	X	X	-	
PBDM-3216/AXCS	X	X	X	X	

CHAMPIONSHIP MAPLE SERIES

SONIC-CUT TENORS

SHELLS: 6 PLY 100% MAPLE w/REINFORCEMENT RINGS
HEADS: CT

STANDARD COVERED FINISHES: • #26 BRUSHED SILVER • #33 PURE WHITE • #46 MIDNIGHT BLACK

SPECIAL ORDER COVERED & LACQUER FINISHES: PLEASE SEE PAGE 46 IN THIS PRICE LIST. NOTE: "400" COVERED FINISHES ARE SUBJECT TO LACQUER PRICING. *SPECIAL ORDERS - PLEASE ALLOW 3 TO 5 MONTHS FOR DELIVERY

SPECIAL ORDER POWDER COATING: • BLACK • WHITE • BLUE • YELLOW • RED • GREEN • ORANGE • PURPLE PLEASE ALLOW 6-8 WEEKS FOR DELIVERY (IF DRUMS ARE IN STOCK).

COVERED - IN STOCK		STANDARD ALUMINUM	POWDER COATED	CHROME PLATED
PMT-8023N/A	QUAD 8,10,12,13 (22.4 LBS)	\$1,515.00	\$2,074.50	\$1,736.00
PMT-0234N/A	QUAD 10,12,13,14 (26 LBS)	1,705.00	2,223.00	1,951.00
PMT-68023N/A	QUINT 6,8,10,12,13 (25.3 LBS)	1,884.00	2,516.50	2,161.00
PMT-60234N/A	QUINT 6,10,12,13,14 (28.9 LBS)	2,074.00	2,665.00	2,376.00
PMT-668023N/A	SEXTET 6,6,8,10,12,13 (28.2 LBS)	2,253.00	2,958.50	2,586.00
PMT-660234N/A	SEXTET 6,6,10,12,13,14 (31.8 LBS)	2,443.00	3,107.00	2,801.00
PMT-680234N/A	SEXTET 6,8,10,12,13,14 (31.8 LBS)	2,351.00	2,974.00	2,681.00
PT-68P/A	6"x8" & 8"x8" SET w/MTG BRKTS	646.00	751.00	730.00
PT-0608N/A	6"x8" TOM	362.00	435.00	418.00
PT-0808/A	8"x8" TOM - UNDRILLED	374.50	454.00	430.50
PT-1010/A	10"x10" TOM - UNDRILLED	411.50	497.50	468.50
PT-1212/A	12"x12" TOM - UNDRILLED	468.50	578.00	548.50
PT-1312/A	13"x12" TOM - UNDRILLED	525.00	640.50	606.00
PT-1413/A	14"x13" TOM - UNDRILLED	582.50	705.00	665.00

LACQUER - *SPECIAL ORDER		STANDARD ALUMINUM	POWDER COATED	CHROME PLATED
PMTL-8023N/A*	QUAD 8,10,12,13 (22.4 LBS)	\$1,851.00	\$2,260.50	\$2,029.00
PMTL-0234N/A*	QUAD 10,12,13,14 (26 LBS)	2,070.00	2,472.00	2,269.00
PMTL-68023N/A*	QUINT 6,8,10,12,13 (25.3 LBS)	2,301.00	2,807.00	2,525.00
PMTL-60234N/A*	QUINT 6,10,12,13,14 (28.9 LBS)	2,520.00	3,018.50	2,765.00
PMTL-668023N/A*	SEXTET 6,6,8,10,12,13 (28.2 LBS)	2,751.00	3,353.50	3,021.00
PMTL-660234N/A*	SEXTET 6,6,10,12,13,14 (31.8 LBS)	2,970.00	3,565.00	3,261.00
PMTL-680234N/A*	SEXTET 6,8,10,12,13,14 (31.8 LBS)	2,852.00	3,315.50	3,117.00
PTL-68P/A*	6"x8" & 8"x8" SET w/MTG BRKTS	782.00	843.50	848.00
PTL-0608N/A*	6"x8" TOM	443.00	539.50	489.00
PTL-0808/A*	8"x8" TOM - UNDRILLED	477.00	573.00	523.00
PTL-1010/A*	10"x10" TOM - UNDRILLED	516.00	612.00	561.00
PTL-1212/A*	12"x12" TOM - UNDRILLED	589.00	681.00	655.00
PTL-1312/A*	13"x12" TOM - UNDRILLED	661.00	752.00	728.00
PTL-1413/A*	14"x13" TOM - UNDRILLED	706.00	795.50	773.00

COVERED TENORS / PEARL CARRIER / STAND / CASE PACKAGES

QUADS

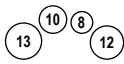
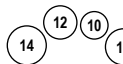
PMT-8023N/A	QUAD PACKAGES	PMT-8023N/A DRUMS	CXT-1 CARRIER	MTS-3000 STAND	PD-8004 CASE	STANDARD ALUMINUM	PMT-0234N/A	QUAD PACKAGES	PMT-0234N/A DRUMS	CXT-1 CARRIER	MTS-3000 STAND	PD-8004 CASE	STANDARD ALUMINUM
	PMT-8023/ACN	X	-	-	X	\$1,798.50		PMT-0234/ACN	X	-	-	X	\$1,988.50
	PMT-8023/AXN	X	X	-	-	2,005.50		PMT-0234/AXN	X	X	-	-	2,195.50
	PMT-8023/AXCN	X	X	-	X	2,289.00		PMT-0234/AXCN	X	X	-	X	2,479.00
	PMT-8023/AXSN	X	X	X	-	2,321.50		PMT-0234/AXSN	X	X	X	-	2,511.50
	PMT-8023/AXCSN	X	X	X	X	2,605.00		PMT-0234/AXCSN	X	X	X	X	2,795.00

QUINTS

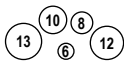
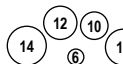
PMT-68023N/A	QUINT PACKAGES	PMT-68023N/A DRUMS	CXT-1 CARRIER	MTS-3000 STAND	PD-8004 CASE	STANDARD ALUMINUM	PMT-60234N/A	QUINT PACKAGES	PMT-60234N/A DRUMS	CXT-1 CARRIER	MTS-3000 STAND	PD-8004 CASE	STANDARD ALUMINUM
	PMT-68023/ACN	X	-	-	X	\$2,167.50		PMT-60234/ACN	X	-	-	X	\$2,357.50
	PMT-68023/AXN	X	X	-	-	2,374.50		PMT-60234/AXN	X	X	-	-	2,564.50
	PMT-68023/AXCN	X	X	-	X	2,658.00		PMT-60234/AXCN	X	X	-	X	2,848.00
	PMT-68023/AXSN	X	X	X	-	2,690.50		PMT-60234/AXSN	X	X	X	-	2,880.50
	PMT-68023/AXCSN	X	X	X	X	2,974.00		PMT-60234/AXCSN	X	X	X	X	3,164.00

SEXTETS

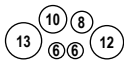
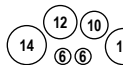
PMT-668023N/A	SEXTET PACKAGES	PMT-668023N/A DRUMS	CXT-1 CARRIER	MTS-3000 STAND	PD-8004 CASE	STANDARD ALUMINUM	PMT-660234N/A	SEXTET PACKAGES	PMT-660234N/A DRUMS	CXT-1 CARRIER	MTS-3000 STAND	PD-8004 CASE	STANDARD ALUMINUM
	PMT-668023/ACN	X	-	-	X	\$2,536.50		PMT-660234/ACN	X	-	-	X	\$2,726.50
	PMT-668023/AXN	X	X	-	-	2,743.50		PMT-660234/AXN	X	X	-	-	2,933.50
	PMT-668023/AXCN	X	X	-	X	3,027.00		PMT-660234/AXCN	X	X	-	X	3,217.00
	PMT-668023/AXSN	X	X	X	-	3,059.50		PMT-660234/AXSN	X	X	X	-	3,249.50
	PMT-668023/AXCSN	X	X	X	X	3,343.00		PMT-660234/AXCSN	X	X	X	X	3,533.00

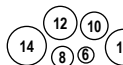
PMT-680234N/A	SEXTET PACKAGES	PMT-680234N/A DRUMS	CXT-1 CARRIER	MTS-3000 STAND	PD-8004 CASE	STANDARD ALUMINUM
	PMT-680234/ACN	X	-	-	X	\$2,634.50
	PMT-680234/AXN	X	X	-	-	2,841.50
	PMT-680234/AXCN	X	X	-	X	3,125.00
	PMT-680234/AXSN	X	X	X	-	3,157.50
	PMT-680234/AXCSN	X	X	X	X	3,441.00

NEW

CHAMPIONSHIP MAPLE SERIES

SONIC-CUT TENORS

SHELLS: 6 PLY 100% MAPLE w/REINFORCEMENT RINGS

HEADS: CT

STANDARD COVERED FINISHES: • #33 PURE WHITE • #46 MIDNIGHT BLACK

NEW STANDARD LACQUER FINISH: • #360 SILVER SPARKLE

NEW SPECIAL ORDER COVERED, LACQUER & "VARSITY" FINISHES: PLEASE SEE PAGE 46 IN THIS PRICE LIST. NOTE: "400" COVERED FINISHES ARE SUBJECT TO LACQUER PRICING. *SPECIAL ORDERS - PLEASE ALLOW 3 TO 5 MONTHS FOR DELIVERY

SPECIAL ORDER POWDER COATING: • BLACK • WHITE • BLUE • YELLOW • RED • GREEN • ORANGE • PURPLE PLEASE ALLOW 6-8 WEEKS FOR DELIVERY (IF DRUMS ARE IN STOCK).

COVERED		STANDARD ALUMINUM	POWDER COATED	CHROME PLATED
PMTM-8023/A	QUAD 8,10,12,13 (22.4 LBS)	\$1,591.00	TBD	TBD
PMTM-0234/A	QUAD 10,12,13,14 (26 LBS)	1,790.50		
PMTM-68023/A	QUINT 6,8,10,12,13 (25.3 LBS)	1,995.00		
PMTM-60234/A	QUINT 6,10,12,13,14 (28.9 LBS)	2,194.50		
PMTM-668023/A	SEXTET 6,6,8,10,12,13 (28.2 LBS)	2,399.00		
PMTM-660234/A	SEXTET 6,6,10,12,13,14 (31.8 LBS)	2,598.50		
PMTM-680234/A	SEXTET 6,8,10,12,13,14 (31.8 LBS)	2,469.00		
PMTM-68/A	6"x8" & 8"x8" SET w/MTG BRKTS	678.50		
PMTM-0608/A	6"x8" TOM	380.50		
PMTM-0808/A	8"x8" TOM - UNDRILLED	393.50		
PMTM-1010/A	10"x10" TOM - UNDRILLED	432.50		
PMTM-1212/A	12"x12" TOM - UNDRILLED	492.00		
PMTM-1312/A	13"x12" TOM - UNDRILLED	551.50		
PMTM-1413/A	14"x13" TOM - UNDRILLED	612.00		
LACQUER		STANDARD ALUMINUM	POWDER COATED	CHROME PLATED
PMTML-8023/A	QUAD 8,10,12,13 (22.4 LBS)	\$1,944.00	TBD	TBD
PMTML-0234/A	QUAD 10,12,13,14 (26 LBS)	2,173.50		
PMTML-68023/A	QUINT 6,8,10,12,13 (25.3 LBS)	2,433.00		
PMTML-60234/A	QUINT 6,10,12,13,14 (28.9 LBS)	2,662.50		
PMTML-668023/A	SEXTET 6,6,8,10,12,13 (28.2 LBS)	2,922.00		
PMTML-660234/A	SEXTET 6,6,10,12,13,14 (31.8 LBS)	3,151.50		
PMTML-680234/A	SEXTET 6,8,10,12,13,14 (31.8 LBS)	2,995.00		
PMTML-68/A	6"x8" & 8"x8" SET w/MTG BRKTS	821.50		
PMTML-0608/A	6"x8" TOM	465.50		
PMTML-0808/A	8"x8" TOM - UNDRILLED	501.00		
PMTML-1010/A	10"x10" TOM - UNDRILLED	542.00		
PMTML-1212/A	12"x12" TOM - UNDRILLED	618.50		
PMTML-1312/A	13"x12" TOM - UNDRILLED	694.50		
PMTML-1413/A	14"x13" TOM - UNDRILLED	741.50		

COVERED TENORS / PEARL CARRIER / STAND / CASE PACKAGES

QUADS

PMTM-8023/A

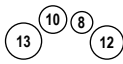

QUAD PACKAGES	PMTM-8023/A DRUMS	CXT-1 CARRIER	MTS-3000 STAND	PD-8004 CASE	STANDARD ALUMINUM
PMTM-8023/AC	X	-	-	X	TBD
PMTM-8023/AX	X	X	-	-	
PMTM-8023/AXC	X	X	-	X	
PMTM-8023/AXS	X	X	X	-	
PMTM-8023/AXCS	X	X	X	X	

PMTM-0234/A

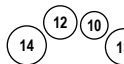

QUAD PACKAGES	PMTM-0234/A DRUMS	CXT-1 CARRIER	MTS-3000 STAND	PD-8004 CASE	STANDARD ALUMINUM
PMTM-0234/AC	X	-	-	X	TBD
PMTM-0234/AX	X	X	-	-	
PMTM-0234/AXC	X	X	-	X	
PMTM-0234/AXS	X	X	X	-	
PMTM-0234/AXCS	X	X	X	X	

QUINTS

PMTM-68023/A

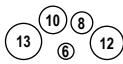

QUINT PACKAGES	PMTM-68023/A DRUMS	CXT-1 CARRIER	MTS-3000 STAND	PD-8004 CASE	STANDARD ALUMINUM
PMTM-68023/AC	X	-	-	X	TBD
PMTM-68023/AX	X	X	-	-	
PMTM-68023/AXC	X	X	-	X	
PMTM-68023/AXS	X	X	X	-	
PMTM-68023/AXCS	X	X	X	X	

PMTM-60234/A

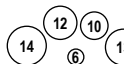

QUINT PACKAGES	PMTM-60234/A DRUMS	CXT-1 CARRIER	MTS-3000 STAND	PD-8004 CASE	STANDARD ALUMINUM
PMTM-60234/AC	X	-	-	X	TBD
PMTM-60234/AX	X	X	-	-	
PMTM-60234/AXC	X	X	-	X	
PMTM-60234/AXS	X	X	X	-	
PMTM-60234/AXCS	X	X	X	X	

SEXTETS

PMTM-668023/A

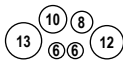

SEXTET PACKAGES	PMT-668023/A DRUMS	CXT-1 CARRIER	MTS-3000 STAND	PD-8004 CASE	STANDARD ALUMINUM
PMTM-668023/AC	X	-	-	X	TBD
PMTM-668023/AX	X	X	-	-	
PMTM-668023/AXC	X	X	-	X	
PMTM-668023/AXS	X	X	X	-	
PMTM-668023/AXCS	X	X	X	X	

PMTM-660234/A

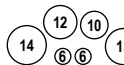

SEXTET PACKAGES	PMT-660234/A DRUMS	CXT-1 CARRIER	MTS-3000 STAND	PD-8004 CASE	STANDARD ALUMINUM
PMTM-660234/AC	X	-	-	X	TBD
PMTM-660234/AX	X	X	-	-	
PMTM-660234/AXC	X	X	-	X	
PMTM-660234/AXS	X	X	X	-	
PMTM-660234/AXCS	X	X	X	X	

PMTM-680234/A

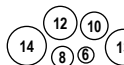

SEXTET PACKAGES	PMTM-680234/A DRUMS	CXT-1 CARRIER	MTS-3000 STAND	PD-8004 CASE	STANDARD ALUMINUM
PMTM-680234/AC	X	-	-	X	TBD
PMTM-680234/AX	X	X	-	-	
PMTM-680234/AXC	X	X	-	X	
PMTM-680234/AXS	X	X	X	-	
PMTM-680234/AXCS	X	X	X	X	

CHAMPIONSHIP MAPLE SERIES

SHALLOW-CUT TENORS

SHELLS: 6 PLY 100% MAPLE w/REINFORCEMENT RINGS

HEADS: CT

STANDARD COVERED FINISHES: • #26 BRUSHED SILVER • #33 PURE WHITE • #46 MIDNIGHT BLACK

SPECIAL ORDER COVERED & LACQUER FINISHES: PLEASE SEE PAGE 46 IN THIS PRICE LIST. NOTE: "400" COVERED FINISHES ARE SUBJECT TO LACQUER PRICING. *SPECIAL ORDERS - PLEASE ALLOW 3 TO 5 MONTHS FOR DELIVERY

SPECIAL ORDER POWDER COATING: • BLACK • WHITE • BLUE • YELLOW • RED • GREEN • ORANGE • PURPLE PLEASE ALLOW 6-8 WEEKS FOR DELIVERY (IF DRUMS ARE IN STOCK).

COVERED - IN STOCK		STANDARD ALUMINUM	POWDER COATED	CHROME PLATED
PSMT-8023N/A	QUAD 8,10,12,13 (22.4 LBS)	\$1,515.00	\$2,074.50	\$1,736.00
PSMT-0234N/A	QUAD 10,12,13,14 (26 LBS)	1,705.00	2,223.00	1,951.00
PSMT-68023N/A	QUINT 6,8,10,12,13 (25.3 LBS)	1,884.00	2,516.50	2,161.00
PSMT-60234N/A	QUINT 6,10,12,13,14 (28.9 LBS)	2,074.00	2,665.00	2,376.00
PSMT-668023N/A	SEXTET 6,6,8,10,12,13 (28.2 LBS)	2,253.00	2,958.50	2,586.00
PSMT-660234N/A	SEXTET 6,6,10,12,13,14 (31.8 LBS)	2,443.00	3,107.00	2,801.00
PSMT-680234N/A	SEXTET 6,8,10,12,13,14 (31.8 LBS)	2,351.00	2,974.00	2,681.00
PT68P/A	6"x8" & 8"x8" SET w/MTG BRKTS	646.00	751.00	730.00
PT0608N/A	6"x8" TOM	362.00	435.00	418.00
PT0808/A	8"x8" TOM - UNDRILLED	374.50	454.00	430.50
PST1009/A	10"x9" TOM - UNDRILLED	411.50	497.50	468.50
PST1210/A	12"x10" TOM - UNDRILLED	468.50	578.00	548.50
PST1310/A	13"x10" TOM - UNDRILLED	525.00	640.50	606.00
PST1411/A	14"x11" TOM - UNDRILLED	582.50	705.00	665.00
LACQUER - *SPECIAL ORDER		STANDARD ALUMINUM	POWDER COATED	CHROME PLATED
PSMTL-8023N/AC*	QUAD 8,10,12,13 (22.4 LBS)	\$1,851.00	\$2,260.50	\$2,029.00
PSMTL-0234N/A*	QUAD 10,12,13,14 (26 LBS)	2,070.00	2,472.00	2,269.00
PSMTL-68023N/A*	QUINT 6,8,10,12,13 (25.3 LBS)	2,301.00	2,807.00	2,525.00
PSMTL-60234N/A*	QUINT 6,10,12,13,14 (28.9 LBS)	2,520.00	3,018.50	2,765.00
PSMTL-668023N/A*	SEXTET 6,6,8,10,12,13 (28.2 LBS)	2,751.00	3,353.50	3,021.00
PSMTL-660234N/A*	SEXTET 6,6,10,12,13,14 (31.8 LBS)	2,970.00	3,565.00	3,261.00
PSMTL-680234N/A*	SEXTET 6,8,10,12,13,14 (31.8 LBS)	2,852.00	3,315.50	3,117.00
PTL-68P/A*	6"x8" & 8"x8" SET w/MTG BRKTS	782.00	843.50	848.00
PTL-0608N/*A	6"x8" TOM	443.00	539.50	489.00
PTL-0808/A*	8"x8" TOM - UNDRILLED	477.00	573.00	523.00
PSTL-1009/A*	10"x9" TOM - UNDRILLED	516.00	612.00	561.00
PSTL-1210/A*	12"x10" TOM - UNDRILLED	589.00	681.00	655.00
PSTL-1310/A*	13"x10" TOM - UNDRILLED	661.00	752.00	728.00
PSTL-1411/A*	14"x11" TOM - UNDRILLED	706.00	795.50	773.00

COVERED SHALLOW-CUT TENORS / PEARL CARRIER / CASE PACKAGES

QUADS

PSMT-8023N/A	QUAD PACKAGES	PSMT-8023N/A DRUMS	CXT-1 CARRIER	MTS-3000 STAND	PD-8004 CASE	STANDARD ALUMINUM	PSMT-0234N/A	QUAD PACKAGES	PSMT-0234N/A DRUMS	CXT-1 CARRIER	MTS-3000 STAND	PD-8004 CASE	STANDARD ALUMINUM
	PSMT-8023/ACN	X	-	-	X	\$1,798.50		PSMT-0234/ACN	X	-	-	X	\$1,988.50
	PSMT-8023/AXN	X	X	-	-	2,005.50		PSMT-0234/AXN	X	X	-	-	2,195.50
	PSMT-8023/AXCN	X	X	-	X	2,289.00		PSMT-0234/AXCN	X	X	-	X	2,479.00
	PSMT-8023/AXSN	X	X	X	-	2,321.50		PSMT-0234/AXSN	X	X	X	-	2,511.50
	PSMT-8023/AXCSN	X	X	X	X	2,605.00		PSMT-0234/AXCSN	X	X	X	X	2,795.00

QUINTS

PSMT-68023N/A	QUINT PACKAGES	PSMT-68023N/A DRUMS	CXT-1 CARRIER	MTS-3000 STAND	PD-8004 CASE	STANDARD ALUMINUM	PSMT-60234N/A	QUINT PACKAGES	PSMT-60234N/A DRUMS	CXT-1 CARRIER	MTS-3000 STAND	PD-8004 CASE	STANDARD ALUMINUM
	PSMT-68023/ACN	X	-	-	X	\$2,167.50		PSMT-60234/ACN	X	-	-	X	\$2,357.50
	PSMT-68023/AXN	X	X	-	-	2,374.50		PSMT-60234/AXN	X	X	-	-	2,564.50
	PSMT-68023/AXCN	X	X	-	X	2,658.00		PSMT-60234/AXCN	X	X	-	X	2,848.00
	PSMT-68023/AXSN	X	X	X	-	2,690.50		PSMT-60234/AXSN	X	X	X	-	2,880.50
	PSMT-68023/AXCSN	X	X	X	X	2,974.00		PSMT-60234/AXCSN	X	X	X	X	3,164.00

SEXTETS

PSMT-668023N/A	SEXTET PACKAGES	PSMT-668023N/A DRUMS	CXT-1 CARRIER	MTS-3000 STAND	PD-8004 CASE	STANDARD ALUMINUM	PSMT-660234N/A	SEXTET PACKAGES	PSMT-660234N/A DRUMS	CXT-1 CARRIER	MTS-3000 STAND	PD-8004 CASE	STANDARD ALUMINUM	
	PSMT-668023/ACN	X	-	-	X	\$2,536.50		PSMT-660234/ACN	X	-	-	X	\$2,726.50	
	PSMT-668023/AXN	X	X	-	-	2,743.50		PSMT-660234/AXN	X	X	-	-	2,933.50	
	PSMT-668023/AXCN	X	X	-	X	3,027.00		PSMT-660234/AXCN	X	X	-	X	3,217.00	
	PSMT-668023/AXSN	X	X	X	-	3,059.50		PSMT-660234/AXSN	X	X	X	-	3,249.50	
	PSMT-668023/AXCSN	X	X	X	X	3,343.00		PSMT-660234/AXCSN	X	X	X	X	3,533.00	
								PSMT-680234N/A	SEXTET PACKAGES	PSMT-680234N/A DRUMS	CXT-1 CARRIER	MTS-3000 STAND	PD-8004 CASE	STANDARD ALUMINUM
								PSMT-680234/ACN	X	-	-	X	\$2,634.50	
								PSMT-680234/AXN	X	X	-	-	2,841.50	
								PSMT-680234/AXCN	X	X	-	X	3,125.00	
								PSMT-680234/AXSN	X	X	X	-	3,157.50	
								PSMT-680234/AXCSN	X	X	X	X	3,441.00	

NEW

CHAMPIONSHIP MAPLE SERIES

SHALLOW-CUT TENORS

SHELLS: 6 PLY 100% MAPLE w/REINFORCEMENT RINGS

HEADS: CT

STANDARD COVERED FINISHES: • #33 PURE WHITE • #46 MIDNIGHT BLACK

NEW STANDARD LACQUER FINISH: • #360 SILVER SPARKLE

NEW SPECIAL ORDER COVERED, LACQUER & "VARSITY" FINISHES: PLEASE SEE PAGE 46 IN THIS PRICE LIST. NOTE: *400" COVERED FINISHES ARE SUBJECT TO LACQUER PRICING. *SPECIAL ORDERS - PLEASE ALLOW 3 TO 5 MONTHS FOR DELIVERY

SPECIAL ORDER POWDER COATING: • BLACK • WHITE • BLUE • YELLOW • RED • GREEN • ORANGE • PURPLE PLEASE ALLOW 6-8 WEEKS FOR DELIVERY (IF DRUMS ARE IN STOCK).

COVERED		STANDARD ALUMINUM	POWDER COATED	CHROME PLATED
PMTMS-8023/A	QUAD 8,10,12,13 (22.4 LBS)	\$1,591.00	TBD	TBD
PMTMS-0234/A	QUAD 10,12,13,14 (26 LBS)	1,790.50		
PMTMS-68023/A	QUINT 6,8,10,12,13 (25.3 LBS)	1,995.00		
PMTMS-60234/A	QUINT 6,10,12,13,14 (28.9 LBS)	2,194.50		
PMTMS-668023/A	SEXTET 6,6,8,10,12,13 (28.2 LBS)	2,399.00		
PMTMS-660234/A	SEXTET 6,6,10,12,13,14 (31.8 LBS)	2,598.50		
PMTMS-680234/A	SEXTET 6,8,10,12,13,14 (31.8 LBS)	2,469.00		
PMTM-68/A	6"x8" & 8"x8" SET w/MTG BRKTS	678.50		
PMTM-0608/A	6"x8" TOM	380.50		
PMTM-0808/A	8"x8" TOM - UNDRILLED	393.50		
PMTMS-1009/A	10"x9" TOM - UNDRILLED	432.50		
PMTMS-1210/A	12"x10" TOM - UNDRILLED	492.00		
PMTMS-1310/A	13"x10" TOM - UNDRILLED	551.50		
PMTMS-1411/A	14"x11" TOM - UNDRILLED	612.00		

LACQUER		STANDARD ALUMINUM	POWDER COATED	CHROME PLATED
PMTMSL-8023/A	QUAD 8,10,12,13 (22.4 LBS)	\$1,944.00	TBD	TBD
PMTMSL-0234/A	QUAD 10,12,13,14 (26 LBS)	2,173.50		
PMTMSL-68023/A	QUINT 6,8,10,12,13 (25.3 LBS)	2,433.00		
PMTMSL-60234/A	QUINT 6,10,12,13,14 (28.9 LBS)	2,662.50		
PMTMSL-668023/A	SEXTET 6,6,8,10,12,13 (28.2 LBS)	2,922.00		
PMTMSL-660234/A	SEXTET 6,6,10,12,13,14 (31.8 LBS)	3,151.50		
PMTMSL-680234/A	SEXTET 6,8,10,12,13,14 (31.8 LBS)	2,995.00		
PMTML-68/A	6"x8" & 8"x8" SET w/MTG BRKTS	821.50		
PMTML-0608/A	6"x8" TOM	465.50		
PMTML-0808/A	8"x8" TOM - UNDRILLED	501.00		
PMTMSL-1009/A	10"x9" TOM - UNDRILLED	542.00		
PMTMSL-1210/A	12"x10" TOM - UNDRILLED	618.50		
PMTMSL-1310/A	13"x10" TOM - UNDRILLED	694.50		
PMTMSL-1411/A	14"x11" TOM - UNDRILLED	741.50		

COVERED SHALLOW-CUT TENORS / PEARL CARRIER / CASE PACKAGES

QUADS

PMTMS-8023/A

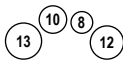

QUAD PACKAGES	PMTMS-8023/A DRUMS	CXT-1 CARRIER	MTS-3000 STAND	PD-8004 CASE	STANDARD ALUMINUM
PMTMS-8023/AC	X	-	-	X	TBD
PMTMS-8023/AX	X	X	-	-	
PMTMS-8023/AXC	X	X	-	X	
PMTMS-8023/AXS	X	X	X	-	
PMTMS-8023/AXCS	X	X	X	X	

PMTMS-0234/A

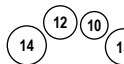

QUAD PACKAGES	PMTMS-0234/A DRUMS	CXT-1 CARRIER	MTS-3000 STAND	PD-8004 CASE	STANDARD ALUMINUM
PMTMS-0234/AC	X	-	-	X	TBD
PMTMS-0234/AX	X	X	-	-	
PMTMS-0234/AXC	X	X	-	X	
PMTMS-0234/AXS	X	X	X	-	
PMTMS-0234/AXCS	X	X	X	X	

QUINTS

PMTMS-68023/A

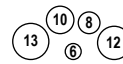

QUINT PACKAGES	PSMT-68023/A DRUMS	CXT-1 CARRIER	MTS-3000 STAND	PD-8004 CASE	STANDARD ALUMINUM
PMTMS-68023/AC	X	-	-	X	TBD
PMTMS-68023/AX	X	X	-	-	
PMTMS-68023/AXC	X	X	-	X	
PMTMS-68023/AXS	X	X	X	-	
PMTMS-68023/AXCS	X	X	X	X	

PMTMS-60234/A

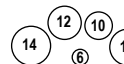

QUINT PACKAGES	PSMT-60234/A DRUMS	CXT-1 CARRIER	MTS-3000 STAND	PD-8004 CASE	STANDARD ALUMINUM
PMTMS-60234/AC	X	-	-	X	TBD
PMTMS-60234/AX	X	X	-	-	
PMTMS-60234/AXC	X	X	-	X	
PMTMS-60234/AXS	X	X	X	-	
PMTMS-60234/AXCS	X	X	X	X	

SEXTETS

PMTMS-668023/A

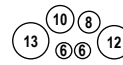

SEXTET PACKAGES	PSMT-668023/A DRUMS	CXT-1 CARRIER	MTS-3000 STAND	PD-8004 CASE	STANDARD ALUMINUM
PMTMS-668023/AC	X	-	-	X	TBD
PMTMS-668023/AX	X	X	-	-	
PMTMS-668023/AXC	X	X	-	X	
PMTMS-668023/AXS	X	X	X	-	
PMTMS-668023/AXCS	X	X	X	X	

PMTMS-660234/A

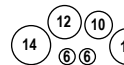

SEXTET PACKAGES	PMTMS-660234/A DRUMS	CXT-1 CARRIER	MTS-3000 STAND	PD-8004 CASE	STANDARD ALUMINUM
PMTMS-660234/AC	X	-	-	X	TBD
PMTMS-660234/AX	X	X	-	-	
PMTMS-660234/AXC	X	X	-	X	
PMTMS-660234/AXS	X	X	X	-	
PMTMS-660234/AXCS	X	X	X	X	

PMTMS-680234/A

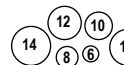

SEXTET PACKAGES	PSMT-680234/A DRUMS	CXT-1 CARRIER	MTS-3000 STAND	PD-8004 CASE	STANDARD ALUMINUM
PMTMS-680234/AC	X	-	-	X	TBD
PMTMS-680234/AX	X	X	-	-	
PMTMS-680234/AXC	X	X	-	X	
PMTMS-680234/AXS	X	X	X	-	
PMTMS-680234/AXCS	X	X	X	X	

CHAMPIONSHIP TRADITIONAL SINGLE TENORS

SHELLS: 6 PLY 100% MAPLE w/REINFORCEMENT RINGS STANDARD COVERED FINISHES: • #26 BRUSHED SILVER • #33 PURE WHITE • #46 MIDNIGHT BLACK HEADS: CT
 SPECIAL ORDER POWDER COATING: • BLACK • WHITE • BLUE • YELLOW • RED • GREEN • ORANGE • PURPLE PLEASE ALLOW 6-8 WEEKS FOR DELIVERY (IF DRUMS ARE IN STOCK).

COVERED

		ALUMINUM	POWDER COATED	CHROME
PTD-1412N/A	14"x12" TRADITIONAL TENOR w/FULLY ROUNDED BEARING EDGES, LIGHT-WEIGHT ALUMINUM SINGLE LUGS, SUPERHOOP II (10.4 LBS)	\$617.50	\$711.00	\$648.50
PTD-1512N/A	15"x12" TRADITIONAL TENOR w/FULLY ROUNDED BEARING EDGES, LIGHT-WEIGHT ALUMINUM SINGLE LUGS, SUPERHOOP II (10.9 LBS)	680.50	783.00	715.00
PTD-1614N/A	16"x14" TRADITIONAL TENOR w/FULLY ROUNDED BEARING EDGES, LIGHT-WEIGHT ALUMINUM SINGLE LUGS, SUPERHOOP II (11.8 LBS)	718.00	826.00	754.00
NEW PTDM-1412/A*	14"x12" TRADITIONAL TENOR w/FULLY ROUNDED BEARING EDGES, LIGHT-WEIGHT ALUMINUM SINGLE LUGS, SUPERHOOP II (10.4 LBS)	648.50	TBD	TBD
NEW PTDM-1512/A*	15"x12" TRADITIONAL TENOR w/FULLY ROUNDED BEARING EDGES, LIGHT-WEIGHT ALUMINUM SINGLE LUGS, SUPERHOOP II (10.9 LBS)	715.00	TBD	TBD
NEW PTDM-1614/A*	16"x14" TRADITIONAL TENOR w/FULLY ROUNDED BEARING EDGES, LIGHT-WEIGHT ALUMINUM SINGLE LUGS, SUPERHOOP II (11.8 LBS)	754.00	TBD	TBD

*PTDM TENORS ONLY AVAILABLE IN #33 PURE WHITE & #46 MIDNIGHT BLACK COVERED FINISHES

COMPETITOR SERIES MARCHING DRUMS

SHELLS: 6 PLY POPLAR/KAPUR
 HEADS: CC BATTER, ST SNARE
 STANDARD HARDWARE FINISHES: POLISHED ALUMINUM
 STANDARD COVERED FINISHES: • #33 PURE WHITE • #46 MIDNIGHT BLACK

SNARE DRUMS

HEADS: CC BATTER & ST SNARE SIDE

CMSX-1412/C	14"x12" HIGH TENSION (13.9 LBS) #33 OR #46	\$764.00
CMSX-1311/C	13"x11" HIGH TENSION (12.9 LBS) #33 OR #46	696.00
CMS-1412/C	14"x12" TRADITIONAL (11.8 LBS) #33 OR #46	515.00
CMS-1309/C	13"x9" TRADITIONAL (<10 LBS) #33 OR #46	442.00

POLISHED ALUMINUM HW ON CMSX SNARE DRUMS
 POPLAR / KAPUR SHELLS

COMPETITOR SNARE DRUM / PEARL CARRIER PACKAGES

PACKAGE #	DRUM	SIZE	CARRIER	MSRP
CMSX-1412/CXN	CMSX-1412/C	14"x12"	MXS-1	\$1,035.00
CMSX-1311/CXN	CMSX-1311/C	13"x11"	MXS-1	967.00
CMS-1412/CXN	CMS-1412/C	14"x12"	MXS-1	786.00
CMS-1309/CXN	CMS-1309/C	13"x9"	MXS-1	713.00

BASS DRUMS

HEADS: REMO SMOOTH WHITE AMBASSADORS

CMB-1414N/C	14"x14" (11.5 LBS) #33 PURE WHITE OR #46 MIDNIGHT BLACK	\$577.50
CMB-1614N/C	16"x14" (14.1 LBS) #33 PURE WHITE OR #46 MIDNIGHT BLACK	583.50
CMB-1814N/C	18"x14" (15.5 LBS) #33 PURE WHITE OR #46 MIDNIGHT BLACK	640.00
CMB-2014N/C	20"x14" (16.2 LBS) #33 PURE WHITE OR #46 MIDNIGHT BLACK	690.00
CMB-2214N/C	22"x14" (18.9 LBS) #33 PURE WHITE OR #46 MIDNIGHT BLACK	764.00
CMB-2414N/C	24"x14" (20.4 LBS) #33 PURE WHITE OR #46 MIDNIGHT BLACK	797.50
CMB-2614N/C	26"x14" (21.0 LBS) #33 PURE WHITE OR #46 MIDNIGHT BLACK	831.50
CMB-2814N/C	28"x14" (22.8 LBS) #33 PURE WHITE OR #46 MIDNIGHT BLACK	916.50

POPLAR / KAPUR SHELLS

COMPETITOR BASS DRUM & PEARL CARRIER PACKAGES

PACKAGE #	DRUM	SIZE	CARRIER	MSRP
CMB-1414/CXN	CMB-1414N/C	14"x14"	MXB-1	\$809.00
CMB-1614/CXN	CMB-1614N/C	16"x14"	MXB-1	815.00
CMB-1814/CXN	CMB-1814N/C	18"x14"	MXB-1	871.50
CMB-2014/CXN	CMB-2014N/C	20"x14"	MXB-1	921.50
CMB-2214/CXN	CMB-2214N/C	22"x14"	MXB-1	995.50
CMB-2414/CXN	CMB-2414N/C	24"x14"	MXB-1	1,029.00
CMB-2614/CXN	CMB-2614N/C	26"x14"	MXB-1	1,063.00
CMB-2814/CXN	CMB-2814N/C	28"x14"	MXB-1	1,148.00

TOMS

HEADS: CT

CMT-8023N/C	QUAD 8,10,12,13 (18.7 LBS) #33 OR #46	\$888.00
CMT-802N/C	TRIO 8,10,12 (12 LBS) #33 OR #46	640.00
CMT-0808/C	8"x8" #33 PURE WHITE OR #46 MIDNIGHT BLACK	210.50
CMT-1009/C	10"x9" #33 PURE WHITE OR #46 MIDNIGHT BLACK	238.00
CMT-1210/C	12"x10" #33 PURE WHITE OR #46 MIDNIGHT BLACK	272.00
CMT-1311/C	13"x11" #33 PURE WHITE OR #46 MIDNIGHT BLACK	294.50

POPLAR / KAPUR SHELLS

COMPETITOR QUAD / TRIO & PEARL CARRIER PACKAGES

PACKAGE #	DRUMS	SIZES	CARRIER	MSRP
CMT-8023/CXN	CMT-8023N/C	8-10-12-13	MXT4-1	\$1,221.00
CMT-802/CXN	CMT-802N/C	8-10-12	MXT3-1	944.50

PIPE BAND SERIES DRUMS

STANDARD HIGH GLOSS LACQUER FINISHES: • #109 ARCTIC WHITE • #110 SEQUOIA RED • #122 BLACK MIST • #126 EMERALD MIST
 SPECIAL ORDER LACQUER FINISHES: PLEASE SEE PAGE 41 IN THIS PRICE LIST
 SPECIAL ORDER POWDER COATING: • BLACK • WHITE • BLUE • YELLOW • RED • GREEN • ORANGE • PURPLE PLEASE ALLOW 6-8 WEEKS FOR DELIVERY (IF DRUMS ARE IN STOCK).

SNARE DRUMS

HEADS: REMO CYBERMAX BATTER & SA-0114 SNARE

BIRCH

	POLISHED ALUMINUM	POWDER COATED	CHROME
FFXPMD-1412 14"x12" MEDALIST w/LOWER WEIGHT (13.8 LBS)	\$1,394.00	\$1,676.00	\$1,754.00

BASS DRUMS

HEADS: REMO SMOOTH WHITE AMBASSADORS

MAPLE

	POLISHED ALUMINUM	POWDER COATED	CHROME
BDP-2612 26"x12" w/POLISHED ALUMINUM TUBE LUGS	\$1,170.00	\$1,366.00	\$1,283.00
BDP-2812 28"x12" w/POLISHED ALUMINUM TUBE LUGS (18.15 LBS)	1,292.00	1,488.50	1,404.00
BDP-2814 28"x14" w/POLISHED ALUMINUM TUBE LUGS (19.45 LBS)	1,314.00	1,510.00	1,426.00
BDP-2816 28"x16" w/POLISHED ALUMINUM TUBE LUGS	1,380.00	1,580.50	1,492.00
BDP-3016 30"x16" w/POLISHED ALUMINUM TUBE LUGS	1,623.00	1,854.00	1,756.00
PB-2812N/C 28"x12" W/3-PIECE LUGS (18.5 LBS)	N/A	N/A	1,242.00
PB-2814N/C 28"x14" W/3-PIECE LUGS (20.5 LBS)	N/A	N/A	1,263.00
PB-2816N/C 28"x16" W/3-PIECE LUGS (21.8 LBS)	N/A	N/A	1,306.00

TENOR DRUMS

HEADS: REMO COATED AMBASSADORS

MAPLE

	POLISHED ALUMINUM	POWDER COATED	CHROME
TDP-1412 14"x12" w/WOOD HOOPS/ POLISHED ALUMINUM TUBE LUGS (8.5 LBS)	\$773.00	\$981.00	\$886.00
TDP-1512 15"x12" w/WOOD HOOPS/POLISHED ALUMINUM TUBE LUGS (8.8 LBS)	823.00	1,033.00	935.00
TDP-1612 16"x12" w/WOOD HOOPS/POLISHED ALUMINUM TUBE LUGS (9.1 LBS)	845.00	1,050.50	957.00
TDP-1812 18"x12" w/WOOD HOOPS/POLISHED ALUMINUM TUBE LUGS (10.6 LBS)	993.00	1,206.00	1,106.00
TDP-2012 20"x12" w/WOOD HOOPS/POLISHED ALUMINUM TUBE LUGS	1,143.00	1,184.50	1,255.00
TDP-2014 20"x14" w/WOOD HOOPS/POLISHED ALUMINUM TUBE LUGS	1,319.00	1,319.00	1,432.00
TDP-2212 22"x12" w/WOOD HOOPS/POLISHED ALUMINUM TUBE LUGS	1,336.00	1,337.00	1,448.00
TDP-2214 22"x14" w/WOOD HOOPS/POLISHED ALUMINUM TUBE LUGS	1,363.00	1,364.00	1,475.00

ORCHESTRAL SNARE DRUMS

NEW PHP-1450/G400	14"x5"	LIMITED EDITION PHILHARMONIC 6-PLY MAPLE GOLD HARDWARE w/PADDED BAG (JAN 2015)	\$1,675.00	
NEW PHTRF-1450/C	14"x5"	LIMITED EDITION PHILHARMONIC 20-PLY TAMO (2) MAPLE (12) BIRCH (6) w/PADDED BAG (GREY FADE OVER TAMO) (APR 2015)	1,675.00	
NEW PHBG-1450/C	14"x5"	LIMITED EDITION PHILHARMONIC 6-PLY BUBINGA (2) MAPLE (2) BUBINGA (2) w/PADDED BAG (JULY 2015)	1,675.00	
NEW PHEP-1450/C	14"x5"	LIMITED EDITION PHILHARMONIC VECTORCAST w/PADDED BAG (OCT 2015)	1,675.00	
PHM-1450	14"x5"	PHILHARMONIC SOLID MAPLE w/DIE CAST HOOPS, #103 PIANO BLACK* & #204 WALNUT BORDEAUX	1,906.50	
PHM-1465	14"x6.5"	PHILHARMONIC SOLID MAPLE w/DIE CAST HOOPS, #103 PIANO BLACK* & #204 WALNUT BORDEAUX	1,917.00	
PHP-1340	13"x4"	PHILHARMONIC 6 PLY MAPLE w/SINGLE FLANGE HOOPS w/CLAW HOOKS, #103 PIANO BLACK & #101 WALNUT	1,061.00	
PHP-1440	14"x4"	PHILHARMONIC 6 PLY MAPLE w/SINGLE FLANGE HOOPS w/CLAW HOOKS, #103 PIANO BLACK & #101 WALNUT	1,153.50	
PHP-1450	14"x5"	PHILHARMONIC 6 PLY MAPLE w/DIE CAST HOOPS, #103 PIANO BLACK & #101 WALNUT	1,174.00	
PHP-1465	14"x6.5"	PHILHARMONIC 6 PLY MAPLE w/DIE CAST HOOPS, #103 PIANO BLACK & #101 WALNUT	1,204.50	
PHP-1480	14"x8"	PHILHARMONIC 6 PLY MAPLE w/DIE CAST HOOPS, #103 PIANO BLACK & #101 WALNUT	1,409.50	
PHA-1440	14"x4"	PHILHARMONIC 3MM CAST ALUMINUM w/SINGLE FLANGE HOOPS w/CLAW HOOKS	1,184.00	
PHA-1450	14"x5"	PHILHARMONIC 3MM CAST ALUMINUM w/DIE CAST HOOPS	1,248.50	
PHA-1465	14"x6.5"	PHILHARMONIC 3MM CAST ALUMINUM w/DIE CAST HOOPS	1,276.00	
PHF-1412	14"x12"	PHILHARMONIC 6 PLY MAPLE FIELD DRUM w/SUPERHOOP II, #103 PIANO BLACK* & #101 WALNUT	1,435.00	
PHF-1616*	16"x16"	PHILHARMONIC 6 PLY MAPLE FIELD DRUM w/SUPERHOOP II, #103 PIANO BLACK* & #101 WALNUT	1,891.50	
PHB-1440	14"x4"	PHILHARMONIC BEADED BRASS w/SGL. FLANGE HOOPS/CLAW HOOKS, VINTAGE SNARE BEDS, BLACK NICKEL FINISH	1,238.00	
PHB-1450	14"x5"	PHILHARMONIC BEADED BRASS w/SGL. FLANGE HOOPS/CLAW HOOKS, VINTAGE SNARE BEDS, BLACK NICKEL FINISH	1,265.00	
PHB-1465	14"x6.5"	PHILHARMONIC BEADED BRASS w/SGL. FLANGE HOOPS/CLAW HOOKS, VINTAGE SNARE BEDS, BLACK NICKEL FINISH	1,312.00	
PHB-1480	14"x8"	PHILHARMONIC BEADED BRASS w/SGL. FLANGE HOOPS/CLAW HOOKS, VINTAGE SNARE BEDS, BLACK NICKEL FINISH	1,532.50	
PHX-1450	14"x5"	PHILHARMONIC AFRICAN MAHOGANY, D/C HOOPS, VINTAGE SNARE BEDS, #210 MATTE WALNUT FINISH	1,174.00	
PHX-1465	14"x6.5"	PHILHARMONIC AFRICAN MAHOGANY, D/C HOOPS, VINTAGE SNARE BEDS, #210 MATTE WALNUT FINISH	1,204.50	
PHX-1580	15"x8"	PHILHARMONIC AFRICAN MAHOGANY, MAPLE HOOPS, VINTAGE SNARE BEDS, #210 MATTE WALNUT FINISH	1,195.00	
PHX-1616	16"x16"	PHILHARMONIC AFRICAN MAHOGANY, MAPLE HOOPS, VINTAGE SNARE BEDS, #210 MATTE WALNUT FINISH	1,891.50	
SYP-1455	14"x5.5"	SYMPHONIC 6 PLY MAPLE w/DIE CAST HOOPS, TUBE LUGS & STAINLESS STEEL TENSION RODS, #138 ANTIQUE SUNBURST	995.00	
SYP-1465	14"x6.5"	SYMPHONIC 6 PLY MAPLE w/DIE CAST HOOPS, TUBE LUGS & STAINLESS STEEL TENSION RODS, #138 ANTIQUE SUNBURST	1,050.00	
CRP-1455	14"x5.5"	CONCERT 6 PLY MAPLE w/SUPERHOOP II, TUBE LUGS, SR-017, RENAISSANCE BATTER, #102 NATURAL & #103 PIANO BLACK	765.00	
CRP-1465	14"x6.5"	CONCERT 6 PLY MAPLE w/SUPERHOOP II, TUBE LUGS, SR-017, RENAISSANCE BATTER, #102 NATURAL & #103 PIANO BLACK	795.00	

- *SR-500 TRIAD SILENT STRAINER
- *3 SNARE TYPES
- *GRADUATED TENSION SNARES
- *THUMBSCREW TENSION ADJUSTERS (3)
- *VINTAGE-STYLE SNARE BEDS
- *EXTREMELY WIDE DYNAMIC RANGE
- *TUBE LUGS
- *STAINLESS STEEL TENSION RODS
- *REMO RENAISSANCE HEADS
- *SPECIAL ORDER

- *SR-300 TRIPLE THROW-OFF
- *3 SNARE TYPES
- *7 SNARE COMBINATIONS
- *7 STRAND STAINLESS STEEL CABLE
- *7 STRANDS THIN YELLOW CABLE
- *ANGLE-MOUNTED SNARES

ORCHESTRAL BASS DRUMS & TOMS

PHILHARMONIC SERIES 6 PLY AFRICAN MAHOGANY #210 MATTE WALNUT LACQUER *SPECIAL ORDER - EXTRA DELIVERY TIME REQUIRED

BASS DRUMS

PBA-2814	28"x14"	\$2,034.50
PBA-3216	32"x16"	2,529.50
PBA-3616	36"x16"	2,882.00
PBA-3618	36"x18"	2,909.50
PBA-2814/S	28"x14" w/STBD STAND	3,264.50
PBA-3216/S	32"x16" w/STBD STAND	3,759.50
PBA-3616/S	36"x16" w/STBD STAND	4,112.00
PBA-3618/S	36"x18" w/STBD STAND	4,139.50

SYMPHONIC SERIES

PBM-2814*	28"x14"	\$1,804.00
PBM-3216*	32"x16"	2,347.00
PBM-3218*	32"x18"	2,374.50
PBM-3616*	36"x16"	2,620.50
PBM-3618	36"x18"	2,647.50
PBM-3620	36"x20"	2,888.50
PBM-3626	36"x26"	3,071.50
PBM-2814/S*	28"x14" w/STBD STAND	3,034.00
PBM-3216/S*	32"x16" w/STBD STAND	3,577.00
PBM-3218/S*	32"x18" w/STBD STAND	3,604.50
PBM-3616/S*	36"x16" w/STBD STAND	3,850.50
PBM-3618/S	36"x18" w/STBD STAND	3,877.50
PBM-3620/S	36"x20" w/STBD STAND	4,118.50
PBM-3626/S	36"x26" w/STBD STAND	4,301.50

CONCERT SERIES

PBE-2814	28"x14"	\$1,288.00
PBE-3216	32"x16"	1,595.50
PBE-3616	36"x16"	1,784.50
PBE-3618	36"x18"	1,866.00
PBE-2814/S	28"x14" w/STBD STAND	2,518.00
PBE-3216/S	32"x16" w/STBD STAND	2,825.50
PBE-3616/S	36"x16" w/STBD STAND	3,014.50
PBE-3616/F	36"x16" w/STBD STAND & FIELD WHEELS	3,037.50
PBE-3618/S	36"x18" w/STBD STAND	3,096.00
PBE-3618/F	36"x18" w/STBD STAND & FIELD WHEELS	3,119.00

SINGLE-HEADED CONCERT TOMS

PTA-0608S*	6"x8" w/BT-3	\$447.50
PTA-0808S*	8"x8" w/BT-3	464.50
PTA-1010S*	10"x10" w/BT-3	509.50
PTA-1210S*	12"x10" w/BT-3	576.00
PTA-1311S*	13"x11" w/BT-3	638.00
PTA-1412S*	14"x12" w/BT-3	695.00
PTA-1514S*	15"x14" w/BT-3	772.00
PTA-1614S*	16"x14" w/BT-3	878.00

SINGLE-HEADED CONCERT TOMS

PTM-0608S*	6"x8" w/BT-3	\$350.50
PTM-0808S*	8"x8" w/BT-3	350.50
PTM-1010S*	10"x10" w/BT-3	425.50
PTM-1210S*	12"x10" w/BT-3	468.50
PTM-1311S*	13"x11" w/BT-3	506.50
PTM-1412S*	14"x12" w/BT-3	576.00
PTM-1514S*	15"x14" w/BT-3	628.00
PTM-1614S*	16"x14" w/BT-3	700.00

CONCERT TOM SETS

PTE-06	6"x8" POPLAR / KAPUR SHELLS - 6 PLY	\$269.50
PTE-08	8"x8" POPLAR / KAPUR SHELLS - 6 PLY	280.00
PTE-10	10"x10" POPLAR / KAPUR SHELLS - 6 PLY	291.00
PTE-12	12"x10" POPLAR / KAPUR SHELLS - 6 PLY	307.50
PTE-13	13"x11" POPLAR / KAPUR SHELLS - 6 PLY	318.00
PTE-14	14"x12" POPLAR / KAPUR SHELLS - 6 PLY	339.50
PTE-15	15"x14" POPLAR / KAPUR SHELLS - 6 PLY	377.00
PTE-16	16"x14" POPLAR / KAPUR SHELLS - 6 PLY	404.00

DOUBLE-HEADED CONCERT TOMS

PTA-0608D*	6"x8" w/BT-3	\$504.00
PTA-0808D	8"x8" w/OPTIMOUNT	525.00
PTA-1010D	10"x10" w/OPTIMOUNT	572.50
PTA-1210D	12"x10" w/OPTIMOUNT	625.00
PTA-1311D	13"x11" w/OPTIMOUNT	730.00
PTA-1412D	14"x12" w/OPTIMOUNT	761.50
PTA-1514D	15"x14" w/OPTIMOUNT	882.00
PTA-1614D	16"x14" w/OPTIMOUNT	934.50

DOUBLE-HEADED CONCERT TOMS

PTM-0608D*	6"x8" w/BT-3	\$460.00
PTM-0808D	8"x8" w/OPTIMOUNT	514.00
PTM-1010D	10"x10" w/OPTIMOUNT	579.50
PTM-1210D	12"x10" w/OPTIMOUNT	627.50
PTM-1311D	13"x11" w/OPTIMOUNT	687.50
PTM-1412D	14"x12" w/OPTIMOUNT	752.00
PTM-1514D	15"x14" w/OPTIMOUNT	817.00
PTM-1614D	16"x14" w/OPTIMOUNT	892.50

CONCERT TOM SETS

PTE-0608	6"x8"/8"x8" w/T-890 STAND	\$720.00
PTE-1012	10"x10"/12"x10" w/T-890 STAND	786.50
PTE-1314	13"x11"/14"x12" w/T-890 STAND	845.00
PTE-1516	15"x14"/16"x14" w/T-890 STAND	995.00

ORCHESTRAL STANDS

CONCERT SNARE STANDS / CYMBAL STANDS / CONCERT TOM STANDS / TIMPANI THRONE





















S-1030LS	GYRO-LOCK SGL. BRACED LEGS 24.8"-31.89"	\$219.00	C-1000SC	GOOSE NECK STAND SGL. BRACED LEGS	\$205.00	D-3000TC	HYDRAULIC TIMPANI THRONE	\$515.50
S-1030L	GYRO-LOCK DBL. BRACED LEGS 25.39"-32.48"	269.00	NEW C-1030SC	GOOSE NECK STAND SGL. BRACED LEGS	205.00	T-1030	DBL TOM STAND 2xTH-1030S w/DBL BR. LEGS	389.00
S-700L	GEAR SGL. BRACED LEGS 23.62"-33.46"	129.00	NEW C-1030AC	CYMBAL CRADLE COMPLETE STAND	239.00	T-930	DBL TOM STAND 2xTH-900S w/DBL BR. LEGS	279.00
			NEW C-103AA	CYMBAL CRADLE ONLY	169.00			

BASS DRUM STANDS

CBS-15	FOLDING STAND	\$205.00	STBD-28	SUSPENDED STAND - 28"	\$1,230.00	BD-014	EYE HOOK FOR SUSPENDED BD STAND (1)	\$7.00
CBS-38C	TILTING STAND w/FOOTREST & CASTERS	540.00	STBD-32	SUSPENDED STAND - 32"	1,230.00	BD-015	RUBBER BAND FOR SUSPENDED BD STAND (1)	6.00
CBS-80S	TILTING STAND - DIRECT DRUM MOUNT - 32"	980.00	STBD-36	SUSPENDED STAND - 36"	1,230.00	250	SET OF 19 BD-015 RUBBER BANDS	90.00
CBS-80M	TILTING STAND - DIRECT DRUM MOUNT - 36"	980.00	STBD-36F	SUSPENDED STAND - 36" w/IFEL FRAME WHEELS	1,253.00			
PMBDL3	MULTI-FIT BASS DRUM LEGS SUSPENDS BASS DRUMS (3 EA) HORIZONTALLY, HEIGHT/TILT ADJ. STANDING HEIGHT VERSION- NO DRILLING	279.00	STBD-40	SUSPENDED STAND - 40"	1,230.00			
PMBDL3C	MULTI-FIT BASS DRUM LEGS SUSPENDS BASS DRUMS (3 EA) HORIZONTALLY, HEIGHT/TILT ADJ. SEATED HEIGHT VERSION- NO DRILLING	332.00						











ADAMS TIMPANI

REVOLUTION

	RVFI20	20" REVOLUTION FIBERGLASS BOWLS	\$3,032.00
	RVFI23	23" REVOLUTION FIBERGLASS BOWLS	3,032.00
	RVFI26	26" REVOLUTION FIBERGLASS BOWLS	3,092.00
	RVFI29	29" REVOLUTION FIBERGLASS BOWLS	3,166.00
	RVFI32	32" REVOLUTION FIBERGLASS BOWLS	3,392.00
	RVFI20FT*	20" REVOLUTION FIBERGLASS BOWLS w/FINE TUNER	3,280.00
	RVFI23FT*	23" REVOLUTION FIBERGLASS BOWLS w/FINE TUNER	3,280.00
	RVFI26FT*	26" REVOLUTION FIBERGLASS BOWLS w/FINE TUNER	3,342.00
	RVFI29FT*	29" REVOLUTION FIBERGLASS BOWLS w/FINE TUNER	3,414.00
	RVFI32FT*	32" REVOLUTION FIBERGLASS BOWLS w/FINE TUNER	3,642.00
	RVKG20FT	20" REVOLUTION POLISHED COPPER BOWLS w/FINE TUNER	3,778.00
	RVKG23FT	23" REVOLUTION POLISHED COPPER BOWLS w/FINE TUNER	3,778.00
	RVKG26FT	26" REVOLUTION POLISHED COPPER BOWLS w/FINE TUNER	3,838.00
	RVKG29FT	29" REVOLUTION POLISHED COPPER BOWLS w/FINE TUNER	3,914.00
	RVKG32FT	32" REVOLUTION POLISHED COPPER BOWLS w/FINE TUNER	4,138.00
	RVKH20FT	20" REVOLUTION HAMMERED COPPER BOWLS w/FINE TUNER ..	4,546.00
	RVKH23FT	23" REVOLUTION HAMMERED COPPER BOWLS w/FINE TUNER ..	4,546.00
	RVKH26FT	26" REVOLUTION HAMMERED COPPER BOWLS w/FINE TUNER ..	4,610.00
	RVKH29FT	29" REVOLUTION HAMMERED COPPER BOWLS w/FINE TUNER ..	4,700.00
	RVKH32FT	32" REVOLUTION HAMMERED COPPER BOWLS w/FINE TUNER ..	5,310.00



*SPECIAL ORDER: 4 TO 6 MONTHS DELIVERY TIME

REVOLUTION TIMPANI PACKAGES

PACKAGE #	SIZES	TYPE	MSRP
 RVFISET2	26, 29	FIBERGLASS	\$6,258.00
 RVFISET4	23, 26, 29, 32	FIBERGLASS	12,682.00
 RVFISET5	20, 23, 26, 29, 32	FIBERGLASS	15,714.00
 RVFISET2FT*	26, 29	FIBERGLASS w/FINE TUNER	6,756.00
 RVFISET4FT*	23, 26, 29, 32	FIBERGLASS w/FINE TUNER	13,678.00
 RVFISET5FT*	20, 23, 26, 29, 32	FIBERGLASS w/FINE TUNER	16,958.00
 RVKGSET2FT	26, 29	POLISHED COPPER w/FINE TUNER	7,752.00
 RVKGSET4FT	23, 26, 29, 32	POLISHED COPPER w/FINE TUNER	15,668.00
 RVKGSET5FT	20, 23, 26, 29, 32	POLISHED COPPER w/FINE TUNER	19,446.00
 RVKHSET2FT	26, 29	HAMMERED COPPER w/FINE TUNER	9,310.00
 RVKHSET4FT	23, 26, 29, 32	HAMMERED COPPER w/FINE TUNER	19,166.00
 RVKHSET5FT	20, 23, 26, 29, 32	HAMMERED COPPER w/FINE TUNER	23,712.00

- * PATENTED FOLDING BASE & BOWL COME APART WITHOUT TOOLS
- * RENAISSANCE TIMPANI HEADS WITH ALUMINUM INSERT RINGS
- * PATENTED WIDE-RANGE HAND FINE TUNER
- * PATENTED BALANCED-ACTION PEDAL SYSTEM
- * PATENTED HEIGHT ADJUSTMENT SYSTEM
- * PATENTED TENSION MECHANISM
- * SHORT COVERS, MUTES & TUNING KEY INCLUDED
- * FIXED THIRD WHEEL w/BRAKE
- * DOUBLE-LOCKING WHEELS
- * TUNING GAUGE

























BAROQUE TIMPANI

	BPKH23*	23" HAMMERED COPPER BOWLS	\$4,546.00
	BPKH26*	26" HAMMERED COPPER BOWLS	4,780.00















*SPECIAL ORDER: 4 TO 6 MONTHS DELIVERY TIME

- * HAMMERED COPPER BOWLS
- * FINE THREAD TUNING SCREW
- * KALFO CALFSKIN HEADS
- * STAND INCLUDED

PROFESSIONAL GENERATION II

	P2FI20	20" GEN II FIBERGLASS	\$3,390.00
	P2FI23	23" GEN II FIBERGLASS	3,390.00
	P2FI26	26" GEN II FIBERGLASS	3,436.00
	P2FI29	29" GEN II FIBERGLASS	3,626.00
	P2FI32	32" GEN II FIBERGLASS	3,742.00
	P2KG20	20" GEN II POLISHED COPPER	4,424.00
	P2KG23	23" GEN II POLISHED COPPER	4,656.00
	P2KG26	26" GEN II POLISHED COPPER	4,724.00
	P2KG29	29" GEN II POLISHED COPPER	5,216.00
	P2KG32	32" GEN II POLISHED COPPER	5,358.00
	P2KH20	20" GEN II HAMMERED COPPER	4,692.00
	P2KH23	23" GEN II HAMMERED COPPER	4,826.00
	P2KH26	26" GEN II HAMMERED COPPER	5,080.00
	P2KH29	29" GEN II HAMMERED COPPER	5,530.00
	P2KH32	32" GEN II HAMMERED COPPER	5,808.00
	P2DH20*	20" GEN II HAMMERED CAMBERED COPPER	5,912.00
	P2DH23*	23" GEN II HAMMERED CAMBERED COPPER	5,978.00
	P2DH26*	26" GEN II HAMMERED CAMBERED COPPER	6,056.00
	P2DH29*	29" GEN II HAMMERED CAMBERED COPPER	6,270.00
	P2DH32*	32" GEN II HAMMERED CAMBERED COPPER	6,940.00
	P2DH20FT	20" GEN II HAMMERED CAMBERED COPPER w/FINE TUNER	6,198.00
	P2DH23FT	23" GEN II HAMMERED CAMBERED COPPER w/FINE TUNER	6,264.00
	P2DH26FT	26" GEN II HAMMERED CAMBERED COPPER w/FINE TUNER	6,342.00
	P2DH29FT	29" GEN II HAMMERED CAMBERED COPPER w/FINE TUNER	6,556.00
	P2DH32FT	32" GEN II HAMMERED CAMBERED COPPER w/FINE TUNER	7,226.00

GENERATION II TIMPANI PACKAGES

PACKAGE #	SIZES	TYPE	MSRP
 P2FISET2	26, 29	FIBERGLASS	\$7,062.00
 P2FISET4	23, 26, 29, 32	FIBERGLASS	14,194.00
 P2FISET5	20, 23, 26, 29, 32	FIBERGLASS	17,584.00
 P2KGSET2	26, 29	SMOOTH COPPER	9,940.00
 P2KGSET4	23, 26, 29, 32	SMOOTH COPPER	19,954.00
 P2KGSET5	20, 23, 26, 29, 32	SMOOTH COPPER	24,378.00
 P2KHSET2	26, 29	HAMMERED COPPER	10,610.00
 P2KHSET4	23, 26, 29, 32	HAMMERED COPPER	21,244.00
 P2KHSET5	20, 23, 26, 29, 32	HAMMERED COPPER	25,936.00
 P2DHSET2*	26, 29	HAMMERED CAMBERED COPPER	12,326.00
 P2DHSET4*	23, 26, 29, 32	HAMMERED CAMBERED COPPER	25,244.00
 P2DHSET5*	20, 23, 26, 29, 32	HAMMERED CAMBERED COPPER	31,156.00
 P2DHSET2FT	26, 29	HAMMERED CAMBERED COPPER w/FINE TUNER	12,898.00
 P2DHSET4FT	23, 26, 29, 32	HAMMERED CAMBERED COPPER w/FINE TUNER	26,388.00
 P2DHSET5FT	20, 23, 26, 29, 32	HAMMERED CAMBERED COPPER w/FINE TUNER	32,586.00











GENERATION II ENDURANCE FIELD WHEELS

PR302F WHEEL SET FOR 1 DRUM \$704.00

- * SINGLE-FLANGE CHROME SUSPENSION RING FOR MAXIMUM PROJECTION
- * RENAISSANCE TIMPANI HEADS WITH INSERT RINGS
- * SUSPENDED BOWL FOR TONAL CLARITY
- * SHORT COVERS, MUTES AND TUNING KEY INCLUDED
- * PATENTED BALANCED SPRING PEDAL SYSTEM
- * DOUBLE-LOCKING WHEELS
- * TUNING GAUGE
- * FIXED 3RD WHEEL w/BRAKE

SYMPHONIC

EUROPEAN TOE-BLOCK PEDAL
WRATCHET FREE LEG OPERATED DESIGN

	SYKH20*	20" SYMPHONIC HAMMERED COPPER	\$6,844.00
	SYKH23*	23" SYMPHONIC HAMMERED COPPER	6,912.00
	SYKH26*	26" SYMPHONIC HAMMERED COPPER	6,988.00
	SYKH29*	29" SYMPHONIC HAMMERED COPPER	7,114.00
	SYKH32*	32" SYMPHONIC HAMMERED COPPER	7,896.00
*SPECIAL ORDER: 4 TO 6 MONTHS DELIVERY TIME			
	SYDH20*	20" SYMPHONIC HAMMERED CAMBERED COPPER	\$8,820.00
	SYDH23*	23" SYMPHONIC HAMMERED CAMBERED COPPER	8,884.00
	SYDH26*	26" SYMPHONIC HAMMERED CAMBERED COPPER	8,954.00
	SYDH29*	29" SYMPHONIC HAMMERED CAMBERED COPPER	9,380.00
	SYDH32*	32" SYMPHONIC HAMMERED CAMBERED COPPER	10,154.00

*SPECIAL ORDER: 4 TO 6 MONTHS DELIVERY TIME

- * HAMMERED COPPER BOWLS FOR CLEAR, PURE TONE
- * RENAISSANCE TIMPANI HEADS w/INSERT RINGS
- * SUSPENSION RING MAINTAINS KETTLE ROUNDNESS, ENSURES STABILITY DURING TRANSPORT
- * LINEAR-FEEL PEDAL ACTION
- * THREE WHEELS w/BRAKES
- * FINE TUNER
- * TUNING GAUGE
- * COVERS INCLUDED

PHILHARMONIC LIGHT

DRESDEN-STYLE PEDAL
W/INFINITELY ADJUSTABLE CLUTCH FORMERLY KNOWN AS THE
CLOYD DUFF DRESDEN SERIES

PLCD20	20" DRESDEN-STYLE w/RENAISSANCE HEADS	\$13,102.00
PLCD23	23" DRESDEN-STYLE w/RENAISSANCE HEADS	13,102.00
PLCD25*	25" DRESDEN-STYLE w/RENAISSANCE HEADS	13,240.00
PLCD26	26" DRESDEN-STYLE w/RENAISSANCE HEADS	13,378.00
PLCD28*	28" DRESDEN-STYLE w/RENAISSANCE HEADS	13,662.00
PLCD29	29" DRESDEN-STYLE w/RENAISSANCE HEADS	14,010.00
PLCD30*	30" DRESDEN-STYLE w/RENAISSANCE HEADS	14,298.00
PLCD32	32" DRESDEN-STYLE w/RENAISSANCE HEADS	14,564.00
PLCD20C*	20" DRESDEN-STYLE w/CALF HEADS	14,298.00
PLCD23C*	23" DRESDEN-STYLE w/CALF HEADS	14,428.00
PLCD25C*	25" DRESDEN-STYLE w/CALF HEADS	14,354.00
PLCD26C*	26" DRESDEN-STYLE w/CALF HEADS	14,706.00
PLCD28C*	28" DRESDEN-STYLE w/CALF HEADS	14,994.00
PLCD29C*	29" DRESDEN-STYLE w/CALF HEADS	15,266.00
PLCD30C*	30" DRESDEN-STYLE w/CALF HEADS	15,546.00
PLCD32C*	32" DRESDEN-STYLE w/CALF HEADS	15,822.00

NOTE: GERMAN-STYLE AVAILABLE ON REQUEST. BERLIN PEDAL AVAILABLE ON REQUEST.
*SPECIAL ORDER: 4 TO 6 MONTHS DELIVERY TIME

PHILHARMONIC LIGHT TIMPANI PACKAGES

PACKAGE #	SIZES	TYPE	MSRP
PLCDSET2	26, 29	AMERICAN	\$27,388.00
PLCDSET4	23, 26, 29, 32	AMERICAN	55,054.00
PLCDSET5	20, 23, 26, 29, 32	AMERICAN	68,156.00

- PATENTED SPLIT ROCKER ARM FOR SUPER-SMOOTH & SILENT PEDAL ACTION
- CHROME PLATED COUNTERHOOPS, TENSION RODS & CENTERING DEVICES
- COPPER HAMMERED CAMBERED BOWLS
- EXTREMELY ACCURATE TUNING GAUGES
- ADJUSTABLE PEDAL PRESSURE
- ADJUSTABLE TILTING MECHANISM
- COVERS & MUTES INCLUDED
- CASTERS w/BRAKES
- FINE TUNER

PHILHARMONIC "DRESDEN CLASSIC"

DRESDEN-STYLE PEDAL
W/RATCHET CLUTCH

PHDCW20L	20" w/WHEELS (AMERICAN SET-UP)	\$13,102.00
PHDCW23L	23" w/WHEELS (AMERICAN SET-UP)	13,102.00
PHDCW26L	26" w/WHEELS (AMERICAN SET-UP)	13,378.00
PHDCW29L	29" w/WHEELS (AMERICAN SET-UP)	14,010.00
PHDCW32L	32" w/WHEELS (AMERICAN SET-UP)	14,564.00
PHDC20*	20" (AMERICAN SET-UP)	13,102.00
PHDC23*	23" (AMERICAN SET-UP)	13,102.00
PHDC26*	26" (AMERICAN SET-UP)	13,378.00
PHDC29*	29" (AMERICAN SET-UP)	14,010.00
PHDC32*	32" (AMERICAN SET-UP)	14,564.00
PHDCW20LC*	20" w/WHEELS & CALF HEADS (AMERICAN SET-UP)	14,298.00
PHDCW23LC*	23" w/WHEELS & CALF HEADS (AMERICAN SET-UP)	14,428.00
PHDCW26LC*	26" w/WHEELS & CALF HEADS (AMERICAN SET-UP)	14,706.00
PHDCW29LC*	29" w/WHEELS & CALF HEADS (AMERICAN SET-UP)	15,266.00
PHDCW32LC*	32" w/WHEELS & CALF HEADS (AMERICAN SET-UP)	15,822.00

NOTE: GERMAN-STYLE AVAILABLE ON REQUEST. BERLIN PEDAL AVAILABLE ON REQUEST.
*SPECIAL ORDERS: 4 TO 6 MONTHS DELIVERY TIME

PHILHARMONIC "DRESDEN CLASSIC" TIMPANI PACKAGES

PACKAGE #	SIZES	TYPE	MSRP
PHDCWSET2L	26, 29 w/WHEELS	AMERICAN	\$27,388.00
PHDCWSET4L	23, 26, 29, 32 w/WHEELS	AMERICAN	55,054.00
PHDCWSET5L	20, 23, 26, 29, 32 w/WHEELS	AMERICAN	68,156.00

- NICKEL-PLATED COUNTER HOOPS, TENSION RODS & CENTERING DEVICES
- SPLIT ROCKER ARM FOR SUPER-SMOOTH SILENT PEDAL ACTION
- RENAISSANCE TIMPANI HEADS w/INSERT RINGS
- EXTREMELY ACCURATE TUNING GAUGES
- PURE AND QUICK RESPONSE WITH A WIDE COLOR RANGE
- SPECIAL DESIGN STRONG CAST STEEL STRUTS
- COPPER HAMMERED CAMBERED BOWLS
- COVERS & MUTES INCLUDED

SCHNELLAR

DRESDEN-STYLE PEDAL
SCHNELLAR BOWL-ACTIVATED TUNING SYSTEM

PLSD20L*	20" DRESDEN PEDAL w/CALF HEADS & ROAD CASE - AMERICAN	\$17,516.00
PLSD23L*	23" DRESDEN PEDAL w/CALF HEADS & ROAD CASE - AMERICAN	18,068.00
PLSD25L*	25" DRESDEN PEDAL w/CALF HEADS & ROAD CASE - AMERICAN	18,068.00
PLSD26L*	26" DRESDEN PEDAL w/CALF HEADS & ROAD CASE - AMERICAN	18,610.00
PLSD28L*	28" DRESDEN PEDAL w/CALF HEADS & ROAD CASE - AMERICAN	18,610.00
PLSD29L*	29" DRESDEN PEDAL w/CALF HEADS & ROAD CASE - AMERICAN	19,162.00
PLSD32L*	32" DRESDEN PEDAL w/CALF HEADS & ROAD CASE - AMERICAN	19,704.00
PLSD20LP*	20" DRESDEN PEDAL w/PLASTIC HEADS & ROAD CASE - AMERICAN	17,516.00
PLSD23LP*	23" DRESDEN PEDAL w/PLASTIC HEADS & ROAD CASE - AMERICAN	18,068.00
PLSD25LP*	25" DRESDEN PEDAL w/PLASTIC HEADS & ROAD CASE - AMERICAN	18,068.00
PLSD26LP*	26" DRESDEN PEDAL w/PLASTIC HEADS & ROAD CASE - AMERICAN	18,610.00
PLSD28LP*	28" DRESDEN PEDAL w/PLASTIC HEADS & ROAD CASE - AMERICAN	18,610.00
PLSD29LP*	29" DRESDEN PEDAL w/PLASTIC HEADS & ROAD CASE - AMERICAN	19,162.00
PLSD32LP*	32" DRESDEN PEDAL w/PLASTIC HEADS & ROAD CASE - AMERICAN	19,704.00

NOTE: GERMAN-STYLE AVAILABLE ON REQUEST
*SPECIAL ORDER: 4 TO 6 MONTHS DELIVERY TIME

PLSD20K*	20" KURBEL (CRANK) w/CALF HEADS & ROAD CASE	\$16,202.00
PLSD23K*	23" KURBEL (CRANK) w/CALF HEADS & ROAD CASE	16,754.00
PLSD25K*	25" KURBEL (CRANK) w/CALF HEADS & ROAD CASE	16,754.00
PLSD26K*	26" KURBEL (CRANK) w/CALF HEADS & ROAD CASE	17,296.00
PLSD28K*	28" KURBEL (CRANK) w/CALF HEADS & ROAD CASE	17,296.00
PLSD29K*	29" KURBEL (CRANK) w/CALF HEADS & ROAD CASE	17,848.00
PLSD32K*	32" KURBEL (CRANK) w/CALF HEADS & ROAD CASE	18,390.00

NOTE: GERMAN-STYLE AVAILABLE ON REQUEST
*SPECIAL ORDER: 4 TO 6 MONTHS DELIVERY TIME

- KALFO CALF HEADS w/RECTANGULAR FLESH HOOPS FOR CLAW TENSION RODS
- COPPER HAMMERED POINTED BOWLS
- BOWL ACTIVATED TUNING SYSTEM
- THREE-LEG BASE SYSTEM
- NICKEL PLATED METAL PARTS
- COVERS & MUTES INCLUDED

TIMPANI KEY / MUFFLER

PBA-02	ADAMS TIMPANI MUTE MUFFLER	\$24.00
PM-100	ADAMS TIMPANI KEY	67.50

TIMPANI BAGS & COVERS

TPCV-20	20" TIMPANI COVER - SHORT	\$82.00	TPRV20	20" REVOLUTION BOWL BAG	\$340.00	TRAPPH20	WOOD HEAD COVER FOR 20" PHIL TIMP	\$236.00
TPCV-23	23" TIMPANI COVER - SHORT	82.00	TPRV23	23" REVOLUTION BOWL BAG	340.00	TRAPPH21	WOOD HEAD COVER FOR 21" PHIL TIMP	236.00
TPCV-25	25" TIMPANI COVER - SHORT	82.00	TPRV26	26" REVOLUTION BOWL BAG	340.00	TRAPPH23	WOOD HEAD COVER FOR 23" PHIL TIMP	236.00
TPCV-26	26" TIMPANI COVER - SHORT	82.00	TPRV29	29" REVOLUTION BOWL BAG	340.00	TRAPPH25	WOOD HEAD COVER FOR 25" PHIL TIMP	236.00
TPCV-28	28" TIMPANI COVER - SHORT	82.00	TPRV32	32" REVOLUTION BOWL BAG	340.00	TRAPPH26	WOOD HEAD COVER FOR 26" PHIL TIMP	236.00
TPCV-29	29" TIMPANI COVER - SHORT	82.00	TPRVB	BAG FOR BASE w/HANDLE & WHEELS	372.00	TRAPPH28	WOOD HEAD COVER FOR 28" PHIL TIMP	236.00
TPCV-30	30" TIMPANI COVER - SHORT	82.00				TRAPPH29	WOOD HEAD COVER FOR 29" PHIL TIMP	236.00
TPCV-32	32" TIMPANI COVER - SHORT	82.00				TRAPPH30	WOOD HEAD COVER FOR 30" PHIL TIMP	236.00
TPCV-20L	20" TIMPANI COVER - LONG	128.00				TRAPPH32	WOOD HEAD COVER FOR 32" PHIL TIMP	236.00
TPCV-23L	23" TIMPANI COVER - LONG	128.00						
TPCV-25L	25" TIMPANI COVER - LONG	128.00						
TPCV-26L	26" TIMPANI COVER - LONG	128.00						
TPCV-28L	28" TIMPANI COVER - LONG	128.00						
TPCV-29L	29" TIMPANI COVER - LONG	128.00						
TPCV-30L	30" TIMPANI COVER - LONG	128.00						
TPCV-32L	32" TIMPANI COVER - LONG	128.00						

ADAMS MALLET INSTRUMENTS

MARIMBAS

	AMPD-30 ACADEMY 3.0 OCTAVE PADOUK w/X-STYLE STAND	\$1,995.00	* CAN BE USED ON A TABLE TOP OR WITH THE INCLUDED HEIGHT-ADJUSTABLE X-STYLE STAND * INTEGRATED RESONATOR/RAIL SYSTEM * COVER & MALLETS INCLUDED
	AMPD-33R ACADEMY 3.3 OCTAVE PADOUK w/RESONATORS & X-STYLE STAND	2,495.00	
	MSHV-43 SOLOIST 4.3 OCTAVE ROSEWOOD w/VOYAGER FRAME - BARS: 2.3"-1.6"	9,126.00	* A=442 HZ TUNED THROUGH THE SIXTH OVERTONE * GRADUATED NARROW BAR CONFIGURATION * GOLD POWDER COATED ESSENTIAL TUBE RESONATORS * HEIGHT-ADJUSTABLE VOYAGER FRAME * COVER & MALLETS INCL
	MSPV-43 SOLOIST 4.3 OCTAVE PADOUK w/VOYAGER FRAME, BARS: 2.3"-1.6"	5,272.00	
	MSPVJ-30 SOLOIST 3.0 OCTAVE PADOUK w/VOYAGER FRAME, BARS: 2.2"-1.6"	3,416.00	
	MCHV-43 CONCERT SERIES 4.3 OCTAVE ROSEWOOD w/VOYAGER FRAME	10,418.00	* A=442 HZ TUNED THROUGH THE SIXTH OVERTONE * GRADUATED WIDE BAR CONFIGURATION 2.6"-1.6" * HEIGHT-ADJUSTABLE VOYAGER OR ENDURANCE FIELD FRAME * GOLD POWDER COATED ESSENTIAL TUBE RESONATORS * COVER & MALLETS INCLUDED
	MCKF-43 CONCERT SERIES 4.3 OCTAVE SYNTHETIC w/ENDURANCE FIELD FRAME	7,560.00	
	MCKV-43 CONCERT SERIES 4.3 OCTAVE SYNTHETIC w/VOYAGER FRAME	6,904.00	
	MCPV-43 CONCERT SERIES 4.3 OCTAVE PADOUK w/VOYAGER FRAME	5,476.00	
	MCRWS-43 SET ROSEWOOD BARS FOR CONCERT 4.3 MARIMBAS	6,653.00	
	MCSYS-43 SET SYNTHETIC BARS FOR CONCERT 4.3 MARIMBAS	6,653.00	
	MCPDS-43 SET PADOUK BARS FOR CONCERT 4.3 MARIMBAS	4,066.00	
	MAHV-50* ARTIST SERIES 5.0 OCTAVE ARTIST ROSEWOOD BARS w/VOYAGER FRAME	20,596.00	* HONDURAS ROSEWOOD BARS 2.75"-1.6" * A=442 HZ TUNED THROUGH THE SIXTH OVERTONE * HEIGHT-ADJUSTABLE VOYAGER OR ENDURANCE FIELD FRAME * GREY POWDERCOAT ARTIST TUNABLE RESONATORS * HEIGHT-ADJUSTABLE VOYAGER OR ENDURANCE FIELD FRAME * COVER & MALLETS INCLUDED
	MAHF-50* ARTIST SERIES 5.0 OCTAVE ARTIST ROSEWOOD BARS w/ENDURANCE FIELD FRAME	22,368.00	
	MAKF-50 ARTIST SERIES 5.0 OCTAVE ARTIST SYNTHETIC BARS w/ENDURANCE FIELD FRAME	20,596.00	
	MAHV-46* ARTIST SERIES 4.6 OCTAVE ARTIST ROSEWOOD BARS w/VOYAGER FRAME	15,590.00	
	MAHF-46* ARTIST SERIES 4.6 OCTAVE ARTIST ROSEWOOD BARS w/ENDURANCE FIELD FRAME	19,776.00	
	MAKF-46 ARTIST SERIES 4.6 OCTAVE ARTIST SYNTHETIC BARS w/ENDURANCE FIELD FRAME	17,322.00	
	MAHV-43* ARTIST SERIES 4.3 OCTAVE ARTIST ROSEWOOD BARS w/VOYAGER FRAME	11,414.00	
	MAHF-43* ARTIST SERIES 4.3 OCTAVE ARTIST ROSEWOOD BARS w/ENDURANCE FIELD FRAME	14,626.00	
	MAKF-43 ARTIST SERIES 4.3 OCTAVE ARTIST SYNTHETIC BARS w/ENDURANCE FIELD FRAME	13,922.00	
	MAHR-AC* ARTIST SERIES "A TO C" CONVERSION KIT	10,272.00	
	MAHR-CA* ARTIST SERIES "C TO A" CONVERSION KIT	1,456.00	* SPECIAL ORDER
	MAHC-55* ARTIST CLASSIC 5.5 OCTAVE C2-G7 ROSEWOOD BARS w/VOYAGER FRAME	23,202.00	* HONDURAS ROSEWOOD BARS 2.75"-1.6" * A=442 HZ TUNED THROUGH THE SIXTH OVERTONE * ARTIST TUNABLE RESONATORS - BLACK POWDERCOAT * HEIGHT-ADJUSTABLE VOYAGER OR ENDURANCE FIELD FRAME * COVER & MALLETS INCLUDED
	MAHC-50* ARTIST CLASSIC 5.0 OCTAVE ROSEWOOD BARS w/VOYAGER FRAME	20,596.00	
	MAHC-43* ARTIST CLASSIC 4.3 OCTAVE ROSEWOOD BARS w/VOYAGER FRAME	11,414.00	
	MAHC-AC* ARTIST CLASSIC "A TO C" CONVERSION KIT	10,272.00	
	MAHC-CA* ARTIST CLASSIC "C TO A" CONVERSION KIT	1,456.00	* SPECIAL ORDER
	MACC-50 ARTIST CLASSIC CUSTOM 5.0 OCTAVE w/VOYAGER FRAME	23,620.00	* HONDURAS ROSEWOOD BARS 2.75"-1.6" * A=442 HZ TUNED THROUGH THE SIXTH OVERTONE * DESERT POWDERCOAT ARTIST TUNABLE RESONATORS * HEIGHT-ADJUSTABLE OAK VOYAGER FRAME * COVER & MALLETS INCLUDED
	MACC-43 ARTIST CLASSIC CUSTOM 4.3 OCTAVE w/VOYAGER FRAME	12,254.00	
	MAHA43 ALPHA SERIES 4.3 OCTAVE ROSEWOOD MARIMBA (PLEASE SPECIFY ALPHA FINISH CODE)	11,414.00	
	MAHA50 ALPHA SERIES 5.0 OCTAVE ROSEWOOD MARIMBA (PLEASE SPECIFY ALPHA FINISH CODE)	20,596.00	
	MAHA-AC* ALPHA ROSEWOOD "A TO C" CONVERSION KIT (PLEASE SPECIFY ALPHA FINISH CODE)	10,272.00	
	MAHA-CA* ALPHA ROSEWOOD "C TO A" CONVERSION KIT (PLEASE SPECIFY ALPHA FINISH CODE)	1,456.00	
	* SPECIAL ORDER		

ALPHA FINISH CODES	ALPHA FINISH CODES	ALPHA FINISH CODES
# RAILS / RESONATORS	# RAILS / RESONATORS	# RAILS / RESONATORS
9G1 GRAPHITE / BLACK	9T1 WALNUT / BLACK	9W1 WHITE WASH / BLACK
9G2 GRAPHITE / DESERT	9T2 WALNUT / DESERT	9W2 WHITE WASH / DESERT
9G3 GRAPHITE / SATIN GOLD	9T3 WALNUT / SATIN GOLD	9W3 WHITE WASH / SATIN GOLD

XYLOPHONES

	AXLD-35 ACADEMY SERIES 3.5 OCTAVE LIGHT ROSEWOOD w/X-STYLE STAND	\$1,595.00	* CAN BE USED ON A TABLE TOP OR WITH THE INCLUDED HEIGHT-ADJUSTABLE X-STYLE STAND * INTEGRATED RESONATOR/RAIL SYSTEM * COVER & MALLETS INCLUDED
	XSKV-35 SOLOIST 3.5 OCTAVE SYNTHETIC BARS w/VOYAGER FRAME	3,390.00	* SYNTHETIC BARS FEATURE SUPERIOR DURABILITY - IDEAL FOR SCHOOLS * BARS: 1.5" (3.5 OCTAVE) * BARS: 1.7"-1.5" (4.0 OCTAVE) * TUNING: A=442 HZ * HEIGHT-ADJUSTABLE VOYAGER OR ENDURANCE FIELD FRAME * COVER & MALLETS INCLUDED
	XSKF-35 SOLOIST 3.5 OCTAVE SYNTHETIC BARS w/ENDURANCE FIELD FRAME	4,272.00	
	XSHV-40 SOLOIST 4.0 OCTAVE ROSEWOOD BARS w/VOYAGER FRAME	5,476.00	
	XSHV-35 SOLOIST 3.5 OCTAVE ROSEWOOD BARS w/VOYAGER FRAME	4,240.00	
	XCHV-40 CONCERT SERIES 4.0 OCTAVE ROSEWOOD BARS w/VOYAGER FRAME	6,778.00	* TUNING: A=442 HZ, BARS: 1.9"-1.5" * HEIGHT-ADJUSTABLE VOYAGER FRAME * RAILS/RESONATORS FOLD IN HALF FOR EASE OF TRANSPORT * COVER & MALLETS INCLUDED
	XAHA40 ALPHA SERIES 4.0 OCTAVE ROSEWOOD (PLEASE SPECIFY ALPHA FINISH CODE)	7,666.00	

ALPHA FINISH CODES	ALPHA FINISH CODES	ALPHA FINISH CODES
# RAILS / RESONATORS	# RAILS / RESONATORS	# RAILS / RESONATORS
9G1 GRAPHITE / BLACK	9T1 WALNUT / BLACK	9W1 WHITE WASH / BLACK
9G2 GRAPHITE / DESERT	9T2 WALNUT / DESERT	9W2 WHITE WASH / DESERT
9G3 GRAPHITE / SATIN GOLD	9T3 WALNUT / SATIN GOLD	9W3 WHITE WASH / SATIN GOLD

VIBRAPHONES

	VSSV31M SOLOIST - SILVER BARS 3.1 OCTAVE w/VOYAGER FRAME WITH MOTOR, E3-F6	\$6,248.00	* TUNING: A=442 HZ * MOTOR WITH SILENT PAUSE CONTROL * GRADUATED ANODIZED SILVER BARS, OR GOLD BARS * COVERED MOTOR & RUBBER BANDS FOR PROTECTION AGAINST OUTSIDE ELEMENTS * ADVANCED DAMPENING SYSTEM w/PEDAL TENSION, DAMPER & HEIGHT ADJUSTMENT * HEIGHT-ADJUSTABLE TRAVELER, VOYAGER OR ENDURANCE FIELD FRAME * TOP-MOUNTED ON/OFF SWITCH & SPEED ADJUSTMENT CONTROL * DUAL CLOSED/OPEN RESONATOR FAN SWITCH CONTROL * COVER & MALLETS INCLUDED
	VSGV31M SOLOIST - GOLD BARS 3.1 OCTAVE w/VOYAGER FRAME WITH MOTOR, E3-F6	6,248.00	
	VCSV30M CONCERT SERIES - SILVER BARS 3 OCTAVE w/VOYAGER FRAME WITH MOTOR, F3-F6	6,686.00	
	VCGV30M CONCERT SERIES - GOLD BARS 3 OCTAVE w/VOYAGER FRAME WITH MOTOR, F3-F6	6,686.00	
	VCSF30M CONCERT SERIES - SILVER BARS 3 OCTAVE w/FIELD FRAME WITH MOTOR, F3-F6	7,524.00	
	VCGF30M CONCERT SERIES - GOLD BARS 3 OCTAVE w/FIELD FRAME WITH MOTOR, F3-F6	7,524.00	
	VCSF30 CONCERT SERIES - SILVER BARS 3 OCTAVE w/FIELD FRAME NO MOTOR, F3-F6	6,686.00	
	VCGF30 CONCERT SERIES - GOLD BARS 3 OCTAVE w/FIELD FRAME NO MOTOR, F3-F6	6,686.00	
	4VBBP01 LONG PEDAL EXTENSION ACCESSORY ADD-ON FOR TRAVELER & FIELD FRAMES	550.00	
	4VBBP02 LONG PEDAL EXTENSION ACCESSORY ADD-ON FOR VOYAGER	550.00	
	VAST30M ALPHA SERIES 3.0 OCTAVE w/SILVER BARS, MOTOR AND TRAVELER FRAME	7,248.00	
	VAGT30M ALPHA SERIES 3.0 OCTAVE w/GOLD BARS, MOTOR AND TRAVELER FRAME	7,248.00	

ALPHA FINISH CODES	ALPHA FINISH CODES	ALPHA FINISH CODES
# RAILS / RESONATORS	# RAILS / RESONATORS	# RAILS / RESONATORS
9G1 GRAPHITE / BLACK	9T1 WALNUT / BLACK	9W1 WHITE WASH / BLACK
9G2 GRAPHITE / DESERT	9T2 WALNUT / DESERT	9W2 WHITE WASH / DESERT
9G3 GRAPHITE / SATIN GOLD	9T3 WALNUT / SATIN GOLD	9W3 WHITE WASH / SATIN GOLD







ADAMS CONCERT BASS DRUMS

MAHOGANY w/ CLEAR LACQUER FINISH













*SPECIAL ORDER - EXTRA DELIVERY TIME REQUIRED

	ABDS2818* 28"x18" w/STBD SUSPENDED STAND	\$3,058.00		ABDS3222* 32"x22" w/STBD SUSPENDED STAND	\$3,538.00		ABDS4018 40"x18" w/STBD SUSPENDED STAND	\$4,180.00
	ABDS2822* 28"x22" w/STBD SUSPENDED STAND	3,058.00		ABDS3618* 36"x18" w/STBD SUSPENDED STAND	3,748.00		ABDS4022 40"x22" w/STBD SUSPENDED STAND	4,180.00
	ABDS3218* 32"x18" w/STBD SUSPENDED STAND	3,538.00		ABDS3622 36"x22" w/STBD SUSPENDED STAND	3,748.00		ABDF4022 40"x22" w/STBD & FIELD WHEELS	4,374.00

BELLS & GLOCKENSPIELS

	GCO-26	CONCERT SERIES 2.6 OCTAVE ORCHESTRA BELLS w/TOLEX CASE	\$3,390.00	<ul style="list-style-type: none"> • 1.25" HIGH-GRADE ROUND TOP BARS • 3.3 OCTAVE C-E • TUNING: AF=42 HZ • PATENT PENDING REVERSIBLE DAMPER SYSTEM • NICKEL PLATED STEEL RESONATORS • COVER & MALLETS INCLUDED
	GCV-33	CONCERT SERIES 3.3 OCTAVE (BLACK FRAME) - NO DAMPER PEDAL	6,388.00	
	GCF-33	CONCERT SERIES 3.3 OCTAVE (BLACK FRAME) w/FIELD FRAME - NO DAMPER PEDAL	6,832.00	
	GAT-33	ARTIST SERIES 3.3 OCTAVE w/TRAVELER FRAME & REVERSIBLE DAMPER PEDAL	6,804.00	
	GAF-33	ARTIST SERIES 3.3 OCTAVE w/FIELD FRAME & REVERSIBLE DAMPER PEDAL	7,430.00	
	GAN-33	ARTIST SERIES 3.3 OCTAVE GLOCKENSPIEL w/VINTAGE TUBE FRAME	7,816.00	

CHIMES

	BK-2001C	STANDARD 1.5 OCTAVE (1.25" DIA TUBES) - CHROME PLATED	\$5,558.00	CHIME COMMON FEATURES: <ul style="list-style-type: none"> • PROPRIETARY BRASS ALLOY TUBES • HEIGHT-ADJUSTABLE ALUMINUM FRAME • DIRECT DAMPING • LARGE WHEELS & BRAKES • COVER AND CHIME HAMMER INCLUDED
	BK-3003C	SYMPHONIC 1.5 OCTAVE (1.5" DIA TUBES) - CHROME PLATED	7,274.00	
	BK-3003CF	SYMPHONIC 1.5 OCTAVE (1.5" DIA TUBES) - CHROME PLATED w/ENDURANCE FIELD FRAME	8,186.00	
	BK-3000C	SYMPHONIC .5 OCTAVE EXTENDED RANGE (F4-B4) - CHROME PLATED - SPECIAL ORDER	6,044.00	
	BK-5003C	PHILHARMONIC 1.5 OCTAVE - CHROME PLATED	9,178.00	
	BK-5003S	*PHILHARMONIC 1.5 OCTAVE - SATIN PLATED - SPECIAL ORDER	9,178.00	
	BK-5000C	PHILHARMONIC .5 OCTAVE EXTENDED RANGE (F4-B4) - CHROME PLATED	6,752.00	PHILHARMONIC EXCLUSIVE FEATURES: <ul style="list-style-type: none"> • EXTRA THICK TUBES PRODUCE CHURCH BELL QUALITY SOUND • W/PERFECT INTONATION & UNRIVALED TONE QUALITY • AVAILABLE IN EITHER CHROME PLATING OR BRASS SATIN FINISH FOR ULTIMATE RESONANCE AND SOUND QUALITY
	BK-5000S	*PHILHARMONIC .5 OCTAVE EXTENDED RANGE (F4-B4) - SATIN PLATED - SPECIAL ORDER	6,752.00	
	2BKFO5H	ACCESSORY CHIME RACK - ADJ. HEIGHT, NO DAMPER-HOLDS 7x1.5" CHIME TUBES	1,486.00	
	BKF-05	ACCESSORY CHIME RACK - NO DAMPER-HOLDS 7x1.5" CHIME TUBES	1,148.00	
	MLBK	ADAMS CHIME Mallet	78.00	
	213	ENDURANCE FIELD FRAME ADD-ON BASE - FITS ALL ADAMS CHIMES	1,560.00	

* SPECIAL ORDER

BELL PLATES













PKG-3	BERLIOZ BELL PLATE G3	\$2,108.50
PKG-4	BERLIOZ BELL PLATE C4	1,962.00

UNIVERSITY FRAMES

NEW UFMAC50	RETRO-FIT FRAME FOR 5.0 ARTIST CLASSIC MARIMBA FRENCH OAK.....	\$2,916.00	NEW UFMAH43	RETRO-FIT FRAME FOR 4.3 ARTIST CLASSIC MARIMBA BLACK TOLEX.....	TBD
NEW UFMAH50	RETRO-FIT FRAME FOR 5.0 ARTIST SERIES MARIMBA BLACK TOLEX.....	2,916.00	NEW UFMAC43	RETRO-FIT FRAME FOR 4.3 CLASSIC SERIES MARIMBA FRENCH OAK.....	TBD
NEW UFMAH46	RETRO-FIT FRAME FOR 4.6 ARTIST SERIES MARIMBA BLACK TOLEX	TBD			

REPLACES EXISTING VOYAGER OR ENDURANCE FIELD FRAME LEGS AND END CAPS

ENDURANCE FIELD FRAMES

	FFMS40	FIELD FRAME FOR SOLOIST 4.0 MARIMBA	\$1,690.00		FFXS35	FIELD FRAME - SOLOIST 3.5 XYLOPHONE	\$1,482.00
	FFMS43	FIELD FRAME FOR SOLOIST 4.3 MARIMBA	1,690.00		FFXS40	FIELD FRAME - SOLOIST 4.0 XYLOPHONE	1,482.00
	FFMC43	FIELD FRAME FOR CONCERT 4.3 MARIMBA	1,690.00		FFXC40	FIELD FRAME - CONCERT 4.0 XYLOPHONE	1,482.00
	FFMA43	FIELD FRAME FOR ARTIST 4.3 MARIMBA	1,690.00		FFVC30	FIELD FRAME - CONCERT 3.0 VIBRAPHONE	1,690.00
	FFMA46	FIELD FRAME FOR ARTIST 4.6 MARIMBA	1,898.00		FFGA33	FIELD FRAME - ARTIST 3.3 GLOCK	1,695.00
	FFMA50	FIELD FRAME FOR ARTIST 5.0 MARIMBA	1,898.00		FFGC33	FIELD FRAME - CONCERT 3.3 GLOCK	1,595.00

ENDURANCE FIELD FRAME PERCUSSION RACK SYSTEM

FFRS-610	FIXED SIDE PANELS w/FIELD FRAME WHEELS & PR 614 BRACES - SET OF 2	\$1,304.00	FFRS-CLCR	ANGLE BRACES FOR EXTENSION ARMS - SET OF 2	\$204.00
FFRSB-10	100CM FIXED CROSSBARS - SET OF 3	376.00	FFRSD-4	40CM EXTENSION ARMS - SET OF 2	132.00
FFRSB-15	150CM FIXED CROSSBARS - SET OF 3	460.00	FFRSB-6	60CM EXTENSION ARMS - SET OF 2	152.00
FFRSB-20	200CM FIXED CROSSBARS - SET OF 3	544.00	FFRSB-8	80CM EXTENSION ARMS - SET OF 2	174.00

RACK SYSTEM ATTACHMENTS

PTT1523MP	MALLET/STICK/TRAP TRAY w/CLAMP 15"x23"	\$229.00	CH-1030	CYMBAL HOLDER w/UNI-LOCK TILTER, 7/8" POST	\$149.00
PTT1215MP	MALLET/STICK/TRAP TRAY w/CLAMP 12"x15"	219.00	CH-930	CYMBAL HOLDER w/UNI-LOCK TILTER, 7/8" POST	99.00
PCX-100	PIPE CLAMP w/ADJUSTABLE JAWS	49.00	CH-830	CYMBAL HOLDER w/GEAR TILTER, 7/8" POST	69.00
PCX-200	PIPE CLAMP w/TILTING CLAMP	55.00	ADP-20	CLAMP w/2 QUICK RELEASE JAWS (5/8" - 1 1/8")	49.00
			AX-25	CLAMP w/2 REVOLVING Q/R CLAMPS (1/2" - 1 1/8")	58.00
			AX-25L	LONG VERSION OF THE AX-25	65.00

ADAMS GONG STAND

ASGS	GONG STAND w/WHEELS - 2 ADJUSTABLE HANGING HOOKS & BUILT-IN MALLET HOOK	\$652.00
626	HANGING HOOKS FOR ASGS - 2 COMPLETE ASSEMBLIES	90.00
627	MALLET HOOK FOR ASGS - 1 COMPLETE ASSEMBLY	45.00

BAGS / COVERS / CORDS

MACV55	SHORT COVER - 5.5 ARTIST CUSTOM MARIMBA MAHV55/MAHC55	\$126.00	CSAB-43	ADAMS SOFT BAGS - 4.3 ARTIST MARIMBA - 2011 SPEC	\$2,244.00
MACV50CC	SHORT COVER - 5.0 ARTIST CUSTOM MARIMBA MACC50	116.00	CSAB-46	ADAMS SOFT BAGS - 4.6 ARTIST MARIMBA - 2011 SPEC	2,680.00
MACV43CC	SHORT COVER - 4.3 ARTIST CUSTOM MARIMBA MACC43	84.00	CSAB-50	ADAMS SOFT BAGS - 5.0 ARTIST MARIMBA - 2011 SPEC	2,814.00
MACV-50	SHORT COVER - 5.0 ARTIST MARIMBA MAHV50 / MAHC50	188.00	CSCB-43	ADAMS SOFT BAGS - 4.3 CONCERT MARIMBA - 2011 SPEC	2,208.00
MACV-46	SHORT COVER - 4.6 ARTIST MARIMBA MAHV46	188.00	CSSB-43	ADAMS SOFT BAGS - 4.3 SOLOIST MARIMBA - 2011 SPEC	2,030.00
MACV-43	SHORT COVER - 4.3 ARTIST MARIMBA MAHV43 / MAHC43	188.00	CSMBSA-30	ADAMS ACADEMY MARIMBA SOFT CASE w/WHEELS	470.00
MCCF-43	SHORT COVER - 4.3 CONCERT MARIMBA w/FIELD FRAME MCKF43	142.00	CSXBC-40	ADAMS SOFT BAGS - 4.0 CONCERT XYLO - 2011 SPEC	1,374.00
MCCV-43	SHORT COVER - 4.3 CONCERT MARIMBA MCHV43 / MCPV43	142.00	CSXB-40	ADAMS SOFT BAGS - 3.5 OR 4.0 SOLOIST XYLO - 2011 SPEC	1,482.00
MSCV-43	SHORT COVER - 4.3 SOLOIST MARIMBA MSPV43	142.00	CSXB-35	ADAMS SOFT BAGS - 3.5 SOLOIST XYLO - NEW 2011	1,504.00
MSCV-40	SHORT COVER - 4.0 SOLOIST MARIMBA MSPV40	142.00	CSXFSA-35	ADAMS ACADEMY XYLOPHONE SOFT CASE w/WHEELS	414.00
XCCV-40	SHORT COVER - 4.0 CONCERT XYLOPHONE XCHV40	132.00	CSVAC-30	ADAMS SOFT BAGS - 3.0 ARTIST/CONCERT VIBES - NEW 2011	1,462.00
XSCV-40	SHORT COVER - 4.0 SOLOIST XYLOPHONE XSHV40	132.00	CD-300	CORD & SPRINGS - XSHV35	\$18.00
XSCV-35	SHORT COVER - 3.5 SOLOIST XYLOPHONE XSKV35 / XSHV35	132.00	CD-301	CORD & SPRINGS - SYNTHETIC XYLO XSKF35 & XSKV35	18.00
XSCF-35	SHORT COVER - 3.5 SOLOIST XYLOPHONE w/FIELD FRAME XSKF35	132.00	CD-320	CORD & SPRINGS - MSPVJ30	18.00
CHCV-ST	LONG COVER - 1.5 BK-2001C CHIME	320.00	CD-350	CORD & SPRINGS - XSHV40	24.00
CHCV-SY	LONG COVER - 1.5 BK-3003 / BK-5003 CHIMES	320.00	CD-351	CORD & SPRINGS - 3.0 VIBRAPHONE	30.00
HC-501	LONG COVER - 0.5 BK-3000 / BK-5000 CHIMES	272.00	CD-370	CORD & SPRINGS - MSPVJ40 OR XC2HV40	30.00
VBCV-30	SHORT COVER - 3.0 CONCERT/ARTIST VIBE CV1 / AV1	148.00	CD-390	CORD & SPRINGS - XCHV40	30.00
VBCF-30	SHORT COVER - 3.0 CONCERT VIBE w/FIELD FRAME CV1F / CV2F	148.00	CD-420	CORD & SPRINGS - MSPV43 OR MSHV43	30.00
HS-214	SHORT COVER - 3.3 GAV / GAC GLOCK	100.00	CD-470	CORD & SPRINGS - 4.3 ARTIST/CONCERT MARIMBAS	42.00
			CD-471	CORD & SPRINGS - 4.3 SYNTHETIC MCKF43 & MCKV43	42.00
			CD-530	CORD & SPRINGS - 4.6 ARTIST MARIMBAS	42.00
			CD-570	CORD & SPRINGS - 5.0 ARTIST MARIMBAS	42.00

ED KITS & COMPONENTS

PL-900C PERC. LEARNING CENTER w/PLBC-9 NYLON CARRYING CASE w/WHEELS \$599.00

• SK-1335P 13"x3.5" WOOD SNARE • 8" REMO TUNEABLE PRACTICE PAD • MUSIC RACK • PKB-32 BELL STAND
• 2.5 OCTAVE BELLS (F5-C8) • MALLETS w/25MM HEADS & WOOD HANDLES • S-70A SNARE BASKET • 5A STICKS

PK-900 PERCUSSION KIT w/PKB-9 NYLON BACKPACK-STYLE CARRYING CASE \$379.00

• 2.5 OCTAVE BELLS (F5-C8) • 8" REMO TUNEABLE PRACTICE PAD • 5A STICKS
• MALLETS w/25MM HEADS & WOOD HANDLES • PKB-32 BELL/PAD STAND • MUSIC RACK

SK-900 SNARE KIT w/SKB-9 NYLON BACKPACK-STYLE CARRYING CASE \$329.00

• SK-1455 14"x5.5" STEEL SNARE • "GLADSTONE" STYLE PRACTICE PAD
• S-700L SNARE STAND • 5A STICKS

SK-900C SNARE KIT w/SKBC-9 NYLON BACKPACK-STYLE CARRYING CASE w/WHEELS 369.00

BELLS & BELL ACCESSORIES

PKB-32 (F5-C8) 32 NOTE BELL SECTION COMPLETE ... \$217.50
PR702A MUSIC RACK 12.50

PRACTICE PADS

RT08PL 8" REMO TUNABLE PRACTICE PAD \$51.00
RPG-14 14" 2-LEVEL PRACTICE PAD 35.00
*SEE PG 17 FOR REPLACEMENT PAD HEADS

CARRYING BAGS/CASES & PARTS

SKB-9 SK-900 CARRYING BAG (ALSO FITS SK-800) \$106.00
SKBC-9 SK-900C BAG w/WHEELS (ALSO FITS SK-800C) 149.50
PKB-9 PK-900 CARRYING BAG (ALSO FITS PK-800) 118.00
PKBC-9 PK-900C BAG w/WHEELS (ALSO FITS PK-800C) 161.50
PLBC-9 PL-900C BAG w/WHEELS 174.00
CRT-100 WHEELED CART ONLY 65.00

SNARE DRUMS

SK-1335P 13"x3.5" WOOD - #31 JET BLACK \$154.50
SK-1455 14"x5.5" STEEL w/0 MUTE - HAIRLINE NICKEL 223.00

STICKS & MALLETS

SPK-5A 5A STICKS \$19.00
PXB-5N BELL MALLETS (WOOD HANDLE) 15.50

STANDS

PK-800ST BELL/PRACTICE PAD STAND - PK-800 & PL-800 .. \$56.50
S-700L SNARE DRUM STAND 129.00
S-70A SNARE STAND BASKET (ONLY) 93.50

REPLACEMENT HEADS - MARCHING / CONCERT / LOGO STICKERS

MARCHING BASS HEADS - PEARL LOGO

14" BR-1214PL SMOOTH WHITE \$62.00
16" BR-1216PL SMOOTH WHITE 64.30
18" BR-1218PL SMOOTH WHITE 66.10
20" BR-1220PL SMOOTH WHITE 68.90
22" BR-1222PL SMOOTH WHITE 73.30
24" BR-1224PL SMOOTH WHITE 78.20
26" BR-1226PL SMOOTH WHITE 87.40
28" BR-1228PL SMOOTH WHITE 94.30
30" BR-1230PL SMOOTH WHITE 102.00
32" BR-1232PL SMOOTH WHITE 109.20
14" ES-1014-00* EBONY 63.60
16" ES-1016-00* EBONY 67.00
18" ES-1018-00* EBONY 70.50
20" ES-1020-00* EBONY 75.50
22" ES-1022-00* EBONY 79.50
24" ES-1024-00* EBONY 83.80
26" ES-1026-00* EBONY 89.70
28" ES-1028-00* EBONY 95.80
30" ES-1030-00* EBONY 109.00
32" ES-1032-00* EBONY 114.00
*SPECIAL ORDER

CONCERT BASS HEADS - PEARL LOGO

28" FA-1528-PL FIBERSKYN III \$112.50
32" FA-1532-PL FIBERSKYN III 139.70
36" FA-1536-PL FIBERSKYN III 169.10
40" FA-1540-PL FIBERSKYN III 205.30
28" N3-3028-PL* NUSKYN 115.80
32" N3-3032-PL* NUSKYN 148.10
36" N3-3036-PL* NUSKYN 188.00
40" N3-3040-PL* NUSKYN 325.50

PEARL LOGO STICKERS

PHD1BMP BLACK DECAL 13"x5.5" \$3.50
PHD1WMP WHITE DECAL 13"x5.5" 3.50
PHD1B BLACK DECAL 9"x4" 3.50
PHD1W WHITE DECAL 9"x4" 3.50
CP1 WHITE DIE-CUT 6"x2.5" 3.50
CP2 BLACK DIE-CUT 6"x2.5" 3.50
CP3 REFLECTIVE DIE-CUT 6"x2.5" 3.50
CP4 GLOW-IN-THE-DARK 6"x2.5" 3.50
CP1MP WHITE DIE-CUT 7.25"x3" 3.50
CP2MP BLACK DIE-CUT 7.25"x3" 3.50
CP1S WHITE DIE-CUT 5.7"x2" 3.50
CP2S BLACK DIE-CUT 5.7"x2" 3.50

MARCHING TOM HEADS

6" PS-0306MP PINSTRIPE \$29.50
8" PS-0308MP PINSTRIPE 32.30
10" PS-0310MP PINSTRIPE 33.60
12" PS-0312MP PINSTRIPE 35.60
13" PS-0313MP PINSTRIPE 37.40
14" PS-0314MP PINSTRIPE 39.00
6" CT-6 PEARL CLEAR 15.50
8" CT-8 PEARL CLEAR 16.50
10" CT-10 PEARL CLEAR 17.50
12" CT-12 PEARL CLEAR 18.50
13" CT-13 PEARL CLEAR 19.50
14" CT-14 PEARL CLEAR 20.50
15" CT-15 PEARL CLEAR 21.00
16" CT-16 PEARL CLEAR 22.00

MARCHING SNARE HEADS - KEVLAR

13" KS-0213-C2 FALAM II w/CLEAR DOT ... \$80.00
14" KS-0214-C2 FALAM II w/CLEAR DOT 81.70
13" KS-0613-00 BLACK MAX 96.60
14" KS-0614-00 BLACK MAX 98.90
13" KS-2613-00 WHITE MAX 96.60
14" KS-2614-00 WHITE MAX 98.90
14" KS-0524-00 CYBERMAX 103.80
13" KL-0213-SA SNARE HEAD 73.80
14" KL-0214-SA SNARE HEAD 75.60

MARCHING SNARE HEADS - PEARL

13" CC-13 CLEAR BATTER w/CLEAR DOT ... \$17.50
14" CC-14 CLEAR BATTER w/CLEAR DOT 20.50
13" ST-13 CLEAR SNARE HEAD 14.50
14" ST-14 CLEAR SNARE HEAD 15.50

REPLACEMENT HEADS - TIMPANI

TIMPANI - PHILHARMONIC

BOWL SIZE	RENAISSANCE	CALFSKIN SKIN ONLY	CALFSKIN COMPLETE SQUARE FLESH HOOP
20"	RC-2300-RA \$173.70	-	4NVLVP20 \$1,816.00
23"	RC-2508-RA 183.70	CATH-23 1,212.00	4NVLVP23 1,834.00
25"	RC-2708-RA 191.40	-	4NVLVP25 1,934.00
26"	RC-2808-RA 195.80	CATH-26 1,288.00	4NVLVP26 1,934.00
28"	RC-3008-RA 208.80	-	4NVLVP28 2,246.00
29"	RC-3200-RA 213.50	CATH-29 1,600.00	4NVLVP29 2,246.00
30"	RC-3300-RA 215.30	-	4NVLVP30 2,264.00
32"	RC-3412-RA 220.90	CATH-32 1,896.00	4NVLVP32 2,560.00

TIMPANI - SYMPHONIC / PROFESSIONAL / UNIVERSAL / REVOLUTION

BOWL SIZE	RENAISSANCE	WEATHERKING HAZY
20"	RC-2200-RA \$169.40	TI-2200-00 \$78.70
23"	RC-2500-RA 182.50	TI-2500-00 87.60
26"	RC-2800-RA 193.50	TI-2800-00 93.00
29"	RC-3100-RA 210.40	TI-3100-00 98.90
32"	RC-3400-RA 219.40	TI-3400-00 115.30

TIMPANI - SYMPHONIC / REVOLUTION

BOWL SIZE	CALFSKIN COMPLETE SQUARE FLESH HOOP
20"	4NVPV20 \$1,786.00
23"	4NVPV23 1,802.00
26"	4NVPV26 1,808.00
29"	4NVPV29 2,214.00
32"	4NVPV32 2,520.00

REPLACEMENT HOOPS - MARCHING / CONCERT / PIPE BAND

CHAMPIONSHIP BASS DRUMS

14" RIM-14PB 2" WIDE MATTE BLACK .. \$77.00
16" RIM-16PB 2" WIDE MATTE BLACK 79.00
18" RIM-18PB 2" WIDE MATTE BLACK ... 85.00
20" RIM-20PB 2" WIDE MATTE BLACK 90.50
22" RIM-22PB 2" WIDE MATTE BLACK ... 101.50
24" RIM-24PB 2" WIDE MATTE BLACK ... 113.00
26" RIM-26PB 2" WIDE MATTE BLACK ... 124.50
28" RIM-28PB 2" WIDE MATTE BLACK ... 147.00
30" RIM-30PB 2" WIDE MATTE BLACK ... 163.50
32" RIM-32PB 2" WIDE MATTE BLACK ... 192.00
14" RIM-14PBJ 2" WIDE GLOSS BLACK .. 90.00
16" RIM-16PBJ 2" WIDE GLOSS BLACK ... 97.00
18" RIM-18PBJ 2" WIDE GLOSS BLACK ... 104.00
20" RIM-20PBJ 2" WIDE GLOSS BLACK ... 111.00
22" RIM-22PBJ 2" WIDE GLOSS BLACK ... 124.50
24" RIM-24PBJ 2" WIDE GLOSS BLACK ... 138.00
26" RIM-26PBJ 2" WIDE GLOSS BLACK ... 152.00
28" RIM-28PBJ 2" WIDE GLOSS BLACK ... 179.50
30" RIM-30PBJ 2" WIDE GLOSS BLACK ... 200.00
32" RIM-32PBJ 2" WIDE GLOSS BLACK ... 234.50

COMPETITOR BASS DRUMS

14" RIM-14CB 1.5" WIDE MATTE BLACK .. \$67.00
16" RIM-16CB 1.5" WIDE MATTE BLACK ... 69.50
18" RIM-18CB 1.5" WIDE MATTE BLACK ... 79.50
20" RIM-20CB 1.5" WIDE MATTE BLACK ... 85.00
22" RIM-22CB 1.5" WIDE MATTE BLACK ... 90.00
24" RIM-24CB 1.5" WIDE MATTE BLACK ... 97.50
26" RIM-26CB 1.5" WIDE MATTE BLACK ... 113.00
28" RIM-28CB 1.5" WIDE MATTE BLACK ... 128.50
14" RIM-14CBJ 1.5" WIDE GLOSS BLACK ... 79.50
16" RIM-16CBJ 1.5" WIDE GLOSS BLACK ... 83.50
18" RIM-18CBJ 1.5" WIDE GLOSS BLACK ... 90.00
20" RIM-20CBJ 1.5" WIDE GLOSS BLACK ... 97.00
22" RIM-22CBJ 1.5" WIDE GLOSS BLACK ... 104.00
24" RIM-24CBJ 1.5" WIDE GLOSS BLACK ... 117.50
26" RIM-26CBJ 1.5" WIDE GLOSS BLACK ... 131.50
28" RIM-28CBJ 1.5" WIDE GLOSS BLACK ... 145.50

CONCERT BASS DRUMS

28" RIM-28PB 2" WIDE MATTE BLACK .. \$143.00
32" RIM-32PB 2" WIDE MATTE BLACK 187.00
36" RIM-36PB 2" WIDE MATTE BLACK 190.00

FFX / FFXP DIE CAST HOOPS

13" DA-13T 10 LUG BATTER \$97.50
13" DA-13B 10 LUG SNARE w/ME-262NA STEEL GUARDS 97.50
13" DA-13BNN 10 LUG SNARE w/AL-93A ALUM. GUARDS ... 97.50
14" DA-14T 12 LUG BATTER 97.50
14" DA-14B 12 LUG SNARE w/ME-262NA STEEL GUARDS 97.50
14" DA-14BNN 12 LUG SNARE w/AL-93A ALUM. GUARDS ... 97.50
ME-262NA STEEL GUARD (1) 6.00
AL-93A ALUMINUM GUARD (1) 11.50

PIPE TENOR 1" WOOD HOOPS

14" RIM-14TDP \$108.00
15" RIM-15TDP 113.00
16" RIM-16TDP 118.00
18" RIM-18TDP 133.50

**NOTE - PLEASE REFER TO PAGE 23 FOR:
CONCERT DIE CAST
SUPERHOOP II
SINGLE FLANGE
1.6MM HOOPS**

REPLACEMENT SNARES - MARCHING / CONCERT / PIPE BAND

PHILHARMONIC

S-052	14" 6 STRAND LIGHT CABLE w/CORDS	\$25.00
S-064	14" 4 STRAND SNAPPY	12.50
S-065Y	14" 5 STRAND HEAVY YELLOW CABLE - GRAD. TENSION	76.00
S-065YE	14" 5 STRAND HEAVY YELLOW CABLE - EVEN TENSION	81.50
S-067YT	14" 7 STRAND LIGHT YELLOW CABLE - GRAD. TENSION	92.50
S-068S	14" 8 STRAND STAINLESS STEEL CABLE - EVEN TENSION	92.50
S-068SGT	14" 8 STRAND STAINLESS STEEL CABLE - GRAD. TENSION	90.50
C-1505SG	15" 5 STRAND SYNTHETIC GUT	39.00
C1505GT	15" 5 STRAND HEAVY YELLOW - GRAD. TENSION	76.00
S-165Y	16" 5 STRAND HEAVY YELLOW CABLE - GRAD. TENSION	81.50
S-165YE	16" 5 STRAND HEAVY YELLOW CABLE - EVEN TENSION	81.50
S-168S	16" 8 STRAND STAINLESS STEEL CABLE - EVEN TENSION	92.50
S-368SGT	13" 8 STRAND UNCOATED STAINLESS CABLE - GT	79.00
S-352	13" 6 STRAND LIGHT CABLE - EVEN TENSION	25.50
S-368S	13" 8 STRAND UNCOATED STAINLESS CABLE - ET	79.00
DC-534A	SNARE CABLE CLAMP - SR-500 STRAINER	5.50
SGR1/2	SNARE GUIDE (PR) - DIE CAST HOOPS	6.00

SYMPHONIC

S-051	14" 6 STRAND SNAPPY w/CORDS	\$12.50
S-052	14" 6 STRAND LIGHT CABLE w/CORDS	25.00
S-053	14" 6 STRAND HEAVY BLUE CABLE	43.00

CONCERT

S-077	CRP SNARE DRUM SNARE UNIT	\$141.00
-------	---------------------------	----------

MARCHING

GS-416A	16 STRAND GUT - 14" FFX1412	\$92.50
GS-316A	16 STRAND GUT - 13" FFX1311/FFXS1309	92.50
GS-142	SYNTHETIC GUT - 14" CMS/CMSX1412	61.50
GS-132	SYNTHETIC GUT - 13" CMS/CMSX1311	61.50

PIPE DRUM

S-505TCPRC	28 STRAND TOP - PREMIER STYLE	\$27.00
S-505SPRC	20 STRAND BOTTOM - PREMIER STYLE	24.00

REPLACEMENT PARTS - MARCHING / CONCERT / PIPE BAND

CHAMPIONSHIP FFX SNARES

S-115RA	STRAINER - THROWOFF SIDE COMPLETE	\$51.50
S-115BA	STRAINER - BUTT SIDE COMPLETE	31.00
ER-14	EDGE RING - 14" FFX	138.50
ER-13	EDGE RING - 13" FFX	138.50
TSP-102N	TENSION POST - FFX1412 w/STD. FINISH	6.50
TSP-102N/K	TSP-102N w/SHINY ANODIZED FINISH	15.50
TSP-1020A/K	FOR FFX1410 w/SHINY ANODIZED FINISH	15.50
TSP-103N	TENSION POST - FFX1311 w/STD. FINISH	6.50
TSP-103N/K	TSP-103N w/SHINY ANODIZED FINISH	15.50
TSP-1039A/K	FOR FFX1309 w/SHINY ANODIZED FINISH	15.50
T-054/6	TENSION ROD w/WASHER 6MMx54MM (6/PK)	7.00
RG-56/24	ROD GUARDS 6MM (24/PK)	7.00
ME-262	BOTTOM SNARE GUARD w/HEX NUTS - STEEL	6.50
NEW AL-93A	BOTTOM SNARE GUARD w/HEX NUTS - ALUM	11.50

CHAMPIONSHIP BASS DRUMS

C-072AL	LUG - FITS ALL CHAMPIONSHIP BD SIZES	\$12.50
DC-5FN/12	SWIVEL NUT (12/PK)	8.50
T-066	TEN. ROD w/WASHER 16"-28" BD 6MMx115MM	4.50
T-067/2	TEN. ROD w/WASHER 30"-32" BD 6MMx130MM (2/PK)	5.00
RG-56/24	ROD GUARDS 6MM (24/PK)	7.00
D-042	CLAW	4.00
EB-1	EYE BOLT ASSY. COMPLETE	6.50

CHAMPIONSHIP TOMS

C-055AL	LUG COMPLETE	\$8.00
DC-5FN/12	SWIVEL NUT (12/PK)	8.50
T-054/6	TENSION ROD w/WASHER 6MMx54MM (6/PK)	7.00
RG-56/24	ROD GUARDS 6MM (24/PK)	7.00
TS-150	TOM SPACER ASSY. COMPLETE	18.50
MTT-100	TOM TRIM 15"	27.50
NP-246A/4	TOM TRIM END BRACKETS (4/PK)	4.50

COMPETITOR SNARE DRUMS

S-14MRA	STRAINER - THROWOFF SIDE COMPLETE	\$36.00
S-14MBA	STRAINER - BUTT SIDE COMPLETE	36.00
ER-14	EDGE RING - CMX1412/C	138.50
ER-13	EDGE RING - CMX1311/C	138.50
TSP-102N/K	TENSION POST - CMX1412/C w/SHINY ANODIZED FINISH	15.50
TSP-103N/K	TENSION POST - CMX1311/C w/SHINY ANODIZED FINISH	15.50
T-054/6	TEN. ROD w/WASHER - CMX1412/C & 1311/C (6/PK)	7.00
HLN-12S	3PC TENSION LUG COMPLETE - CMX1412/C	15.50
HLN-11S	3PC TENSION LUG COMPLETE - CMS1311/C	15.50
DC-6FE/12	SWIVEL NUT - HLN-12S/HLN-11S (12/PK)	9.50
T-056/6	TEN. ROD w/WASHER - CMS1412/C & 1311/C (6/PK)	5.50
CT-1216	CLIP BRACKET ASSY. COMPLETE	15.50

COMPETITOR BASS DRUMS

HLN-14B	3PC TENSION LUG COMPLETE	\$14.50
DC-5FE	SWIVEL NUT (1 @)	3.00
T-066	TENSION ROD w/WASHER 6MMx115MM	4.50
D-042	CLAW	4.00
EB-1	EYE BOLT ASSY. COMPLETE	6.50

COMPETITOR TOMS

SLN-10T	LUG COMPLETE	\$14.50
DC-6FE/12	SWIVEL NUT (12/PK)	9.50
T-056/6	TENSION ROD w/WASHER 5.8MMx56MM (6/PK)	5.50
TS-150	TOM SPACER ASSY. COMPLETE	18.50
MTT-100	TOM TRIM 15"	20.50
NP-246A/4	TOM TRIM END BRACKETS (4/PK)	4.50

PIPE SNARE DRUMS

SR-505T	TOP SNARE UNIT COMPLETE	\$113.00
SR-505B	BOTTOM SNARE UNIT COMPLETE (ONE SIDE ONLY)	72.00
ER-14PBP	EDGE RING	138.50
TSP-102N/K	TENSION POST LONG w/SHINY ANODIZED FINISH	15.50
TSP-102S/K	TENSION POST SHORT w/SHINY ANODIZED FINISH	15.50
T-054/6	TENSION ROD w/WASHER 6MMx54MM (6/PK)	7.00
RG-56/24	ROD GUARDS 6MM (24/PK)	7.00
ME-262	BOTTOM SNARE GUARD w/HEX NUTS	6.50
AL-93A	BOTTOM SNARE GUARD w/HEX NUTS - ALUM	11.50

BDP & PB PIPE BASS DRUMS

TSP-12P	T-POST - 12" & 14" DEPTH - STD. FINISH	\$18.00
TSP-16P	T-POST - 16" DEPTH - STD. FINISH	20.00
TSP-12P/K	T-POST - 12" & 14" DEPTH - SHINY ANODIZED FINISH	20.50
TSP-16P/K	T-POST - 16" DEPTH - SHINY ANODIZED FINISH	21.50
HLN-12B	3PC TENSION LUG COMPLETE - 12" DEPTH PB	12.50
HLN-14B	3PC TENSION LUG COMPLETE - 14" DEPTH PB	14.50
HLN-16B	3PC TENSION LUG COMPLETE - 16" DEPTH PB	24.00
DC-5FE	SWIVEL NUT (1 @) - HLN-12B/14B/16B	3.00
T-066	TENSION ROD w/WASHER 6MMx115MM - 12" ~ 16"	4.50
T-067/2	TENSION ROD w/WASHER 6MMx135MM - 14" (2/PK)	5.00
D-054	CLAW - BDP BASS DRUM	8.00
D-042	CLAW - PB BASS DRUM	4.00
RG-56/24	ROD GUARDS 6MM (24/PK)	7.00
EB-1	EYE BOLT ASSY. COMPLETE	6.50

TDP PIPE TENOR DRUMS

TSP-12P	T-POST - 12" DEPTH - STD. FINISH	\$18.00
TSP-12P/K	T-POST - 12" DEPTH - SHINY ANODIZED FINISH	20.50
T-065	TENSION ROD w/WASHER 6MMx90MM FOR 1" HOOP	4.50
D-054	CLAW	8.00
PR-495A	SLING HOOK w/SPACER	2.50

PTD PIPE TENOR DRUMS

HL-312T	3PC TENSION LUG COMPLETE	\$10.00
DC-6FE/12	SWIVEL NUT (12/PK)	9.50
T-054/6	TENSION ROD w/WASHER 6MMx54MM (6/PK)	7.00
PR-495	SLING HOOK	1.50

REPLACEMENT PARTS - PHILHARMONIC / SYMPHONIC / CONCERT SNARE DRUMS

PHILHARMONIC

SR-500	TRIAD SILENT STRAINER COMPLETE	\$113.00
SR-500A	TRIAD SILENT STRAINER RELEASE SIDE ONLY	68.00
SR-500E	TRIAD SILENT STRAINER BUTT SIDE ONLY	45.50

SYMPHONIC

SR-300	MULTI-TIMBRE STRAINER COMPLETE	\$101.50
SR-300A	MULTI-TIMBRE STRAINER RELEASE SIDE ONLY	88.50
SR-300E	MULTI-TIMBRE STRAINER BUTT SIDE ONLY	14.00

CONCERT

SR-017	STRAINER COMPLETE	\$50.00
SR-17A	RELEASE SIDE ONLY	33.00
SR-18E	BUTT SIDE ONLY	16.50

MARCHING & CONCERT COLORS

COMPETITOR SERIES

- 33 PURE WHITE
- 46 MIDNIGHT BLACK

CARBONPLY SERIES

- 301 CARBON MATTE FINISH

CARBONCORE SERIES

- 368 BLACK SILVER BURST

PLUS: ALL MARCHING
SPECIAL ORDER LACQUER
FINISHES

CHAMPIONSHIP MAPLE

Standard Wrap

- 33 PURE WHITE
- 46 MIDNIGHT BLACK

*Standard Lacquer Finish

- 360 SILVER SPARKLE LACQUER
* FOR NEW SPEC ONLY

Special Order Wrap

- 21 SMOKEY CHROME
- 26 BRUSHED SILVER
- 42 IVORY
- 91 RED WINE
- 92 AURORA BLUE
- 94 CANDY APPLE
- 400 WHITE MARINE PEARL*
- 402 ABALONE*
- 404 AMETHYST*
- 406 BRONZE GLASS*
- 407 RED GLASS*
- 408 PEWTER GLASS*
- 409 DIAMOND GLITTER*

PLUS: ALL MARCHING
SPECIAL ORDER LACQUER
FINISHES

*ALL "400" COVERED
FINISHES ARE SUBJECT TO
LACQUER PRICING.

MARCHING SPECIAL ORDER LACQUERS

- 100 WINE RED LACQUER
- 101 WALNUT LACQUER
- 102 NATURAL MAPLE
- 103 PIANO BLACK
- 109 ARCTIC WHITE
- 110 SEQUOIA RED
- 111 MATTE NATURAL MAPLE
- 113 SHEER BLUE
- 122 BLACK MIST
- 124 MATTE BLACK MIST
- 125 TEAL BLUE
- 126 EMERALD MIST
- 128 VINTAGE SUNBURST
- 142 ROOTBEER FADE
- 143 TWILIGHT FADE
- 148 EMERALD FADE
- 151 PLATINUM MIST
- 152 ANTIQUE GOLD
- 153 SUNRISE FADE
- 154 MIDNIGHT FADE
- 155 SCARLET FADE
- 197 RHYTHM BLUE
- 201 MATTE WALNUT
- 230 CLEAR BIRCH
- 232 RUBY FADE
- 234 BLACK ICE
- 235 CONCORD FADE
- 238 BLACK BURST
- 239 GRAPHITE
- 243 PRUSSIAN BLUE
- 259 CHESTNUT FADE
- 291 CRANBERRY FADE
- 292 MARINE BLUE FADE
- 302 INCA GOLD BURST
- 310 BROOKLYN BURST
- 330 IVORY PEARL
- 331 BLACK PEARL
- 332 RED PEARL
- 333 PURPLE METALLIC
- 334 RED METALLIC
- 335 BLACK CHERRY
- 342 VINTAGE TOBACCO BURST
- 355 ANTIQUE WALNUT
- 356 TANGERINE DREAM
- 363 BLACK SPARKLE FADE
- 368 BLACK SILVER BURST
- 369 PURPLE SPARKLE BURST
- 376 ULTRA BLUE FADE
- 377 SCARLET SPARKLE BURST
- 378 MIDNIGHT SPARKLE
- 388 SHAMROCK GREEN
- 389 MATTE LIQUID AMBER
- 393 PURPLE CRAZE II

CONCERT SNARE DRUMS

PHM	204	HIGH GLOSS WALNUT BORDEAUX
PHP, PHF	101	WALNUT LACQUER
PHP, PHF	103	PIANO BLACK
PHA	-	BRUSHED ALUMINUM
PHB	-	BLACK NICKEL BRASS
PHX	210	MATTE WALNUT (MAHOGANY)
SYP	138	ANTIQUE SUNBURST
CRP	102	NATURAL MAPLE
CRP	103	PIANO BLACK

CONCERT TOMS

PHA	210	MATTE WALNUT (MAHOGANY)
PHM	201	MATTE WALNUT (MAPLE)
PTE	46	MIDNIGHT BLACK

CONCERT BASS DRUMS

PBA	210	MATTE WALNUT (MAHOGANY)
PBM	201	MATTE WALNUT (MAPLE)
PBE	46	MIDNIGHT BLACK

VARSITY LACQUER FINISHES SPECIAL ORDER ONLY

	FADE TOP	FADE BOTTOM	BURST	SPIRAL
BLUE	#962	#961	#960	#990
YELLOW	#965	#964	#963	#991
RED	#968	#967	#966	#992
GREEN	#971	#970	#969	#993
GARNET	#974	#973	#972	#994
PURPLE	#977	#976	#975	#995
ORANGE	#980	#979	#978	#996
BLACK	#982	#981	#368	#997

VARSITY FINISHES USE THE STANDARD SCHOLASTIC COLOR PALETTE. FADES AND BURST ARE DONE OVER A BASE COAT OF #360 SILVER SPARKLE. SPIRAL FINISHES USE A BASE COAT OF BLACK.

IMPORTANT NOTICE

This price list replaces our August 2014 price list reflecting our line of new products. Please refer to the latest Pearl catalogs for more details. Products listed herein may be limited or discontinued. To improve the design, quality and performance of our instruments the Pearl Corporation reserves the right to change specifications and prices without notice. All merchandise will be shipped at prevailing prices. All prices are F.O.B. Nashville, TN and listed in U.S. Dollars.

Pearl Corporation
Corporate Headquarters
549 Metroplex Dr.
P.O. Box 111240
Nashville, Tennessee 37211-3140
(615) 833-4477
FAX (615) 833-6242



RETPL115